

ONKYO®

Contents

DVD Theater System

L-DR7

L-DR7 consists of DVD AV CONTROLLER
PDR-155 and SPEAKER SYSTEM HTP-L7

Instruction Manual

Thank you for purchasing the Onkyo DVD Theater System. Please read this manual thoroughly before making connections and turning on the power. Following the instructions in this manual will enable you to obtain optimum performance and listening enjoyment from your new DVD Theater System. Please retain this manual for future reference.

Introduction

Connections

Setting Up

Playing Back

Enjoying Sound

Setting the Clock

Listening to the Radio

Using the Timer Functions

Recording

Troubleshooting

Miscellaneous



Table of Contents

Getting Started

Introduction

Important Safeguards	4
Precautions.....	6
Features	9
Speaker care.....	10
Handling Discs	11
Supplied Accessories.....	15
Preparing the Remote Controller.....	18
Index to Parts and Controls	19

Connections

Connecting the PDR-155 to a TV	27
If the TV has component jacks:	
If the TV has an S video connector:	
If the TV has neither component jacks nor an S video connector:	
Connecting the DVD AV con- troller (PDR-155) and the subwoofer (SWA-155X)	29
Connecting the subwoofer (SWA-155X) and the speakers (D-M7, D-M3).....	30
Basic positioning example and the role of each speaker	31
Connecting the DVD AV controller (PDR-155) to other components	32
Connecting an MD recorder or tape deck (MD/TAPE IN/ OUT jacks)	32
Connecting a CD recorder or VCR (CDR/VIDEO IN/OUT jacks).....	34
About the RI function	36
Connecting an RI cable	37

Basic Setup

Turning on the PDR-155.....	40
Selecting the Number of Speaker Channels.....	41
Changing the Input Source Setting.....	42
Using Setup Navigator.....	43

Various functions

Setting the Clock

Setting the Day and Time	78
Displaying the Clock.....	80

Operating the TV from Remote Controller

Listening to the Radio

Making Antenna (Aerial) Connections.....	38
Listening to the Radio	81
Tuning Manually	81
Auto Preset Memory — Automatically storing the stations (only for FM)	81
Preset Memory – Receiving and programming your favorite stations.....	83
Using RDS (European models only).....	82
Switching between Auto and Mono mode.....	82
Listening to a preset station	85
Erasing a preset station	85
Entering Characters.....	86
Naming the preset stations	86
Changing the characters	87
Deleting the characters	88

Using the Timer Functions

Using the Timer Functions	89
Using Sleep Timer.....	89
Programming a timer.....	91
Checking the timer settings.....	95
Switching the timer on (activating) or off (deactivating).....	94

Recording

Recording	96
------------------------	-----------

Setting Up Your Home Theater

What is Home Theater?

Enjoying home theater 26

Controlling Playback

Playing a Connected Source 46

Muting the sound 47

Listening through headphones ... 47

Playing DVDs, Video CDs, CDs and MP3s 48

Using the Disc Menu and Title Menu..... 53

Locating a Point..... 54

Playback Alternatives 56

Repeat Playback..... 56

Program Playback..... 57

Random Playback..... 62

Selecting the Camera Angle 63

Selecting the Voice-over/Subtitle Language..... 64

Playing from the Last Location — Last Memory 65

Memorizing the Settings of your Favorite DVDs — Condition Memory 66

Viewing Disc Information..... 67

Advanced Features

Miscellaneous

Customizing the Function Settings 99

Using the Setup window 99

Advanced settings 101

Settings in the Video 1 page.. 102

Adjusting the picture quality .. 104

Settings in the Video 2 page.. 107

Setting the language options . 108

Setting the parental lock level ... 112

Memorizing the settings (Function memory)..... 117

Recalling the settings from Function memory 118

Restoring the PDR-155's factory default settings 118

Enjoying Sound

Boosting the Super Bass/High Ranges..... 70

Using the DIMMER function 70

Enjoying the Surround Sound 71

About surround sound 71

Selecting a surround mode..... 72

Adjusting the listening angle.... 74

Adjusting each speaker's relative volume balance temporarily 75

Using the Late Night function (only for Dolby Digital discs) 75

Advanced Features

Speaker Setup

Setting the Distance to the Speakers..... 76

Balancing the Speaker Volume Levels..... 77

Others

Troubleshooting 121

Specifications 125

WARNING:

TO REDUCE THE RISK OF FIRE OR ELECTRIC SHOCK, DO NOT EXPOSE THIS APPLIANCE TO RAIN OR MOISTURE.

CAUTION:

TO REDUCE THE RISK OF ELECTRIC SHOCK, DO NOT REMOVE COVER (OR BACK). NO USER-SERVICEABLE PARTS INSIDE. REFER SERVICING TO QUALIFIED SERVICE PERSONNEL.



The lightning flash with arrowhead symbol, within an equilateral triangle, is intended to alert the user to the presence of uninsulated "dangerous voltage" within the product's enclosure that may be of sufficient magnitude to constitute a risk of electric shock to persons.

The exclamation point within an equilateral triangle is intended to alert the user to the presence of important operating and maintenance (servicing) instructions in the literature accompanying the appliance.

Important Safeguards

- Read Instructions** — All the safety and operating instructions should be read before the appliance is operated.
- Retain Instructions** — The safety and operating instructions should be retained for future reference.
- Heed Warnings** — All warnings on the appliance and in the operating instructions should be adhered to.
- Follow Instructions** — All operating and use instructions should be followed.
- Cleaning** — Unplug the appliance from the wall outlet before cleaning. The appliance should be cleaned only as recommended by the manufacturer.
- Attachments** — Do not use attachments not recommended by the appliance manufacturer as they may cause hazards.
- Water and Moisture** — Do not use the appliance near water—for example, near a bath tub, wash bowl, kitchen sink, or laundry tub; in a wet basement; or near a swimming pool; and the like.
- Accessories** — Do not place the appliance on an unstable cart, stand, tripod, bracket, or table. The appliance may fall, causing serious injury to a child or adult, and serious damage to the appliance. Use only with a cart, stand, tripod, bracket, or table recommended by the manufacturer, or sold with the appliance. Any mounting of the appliance should follow the manufacturer's instructions, and should use a mounting accessory recommended by the manufacturer.
- An appliance and cart combination should be moved with care. Quick stops, excessive force, and uneven surfaces may cause the appliance and cart combination to overturn.
- Ventilation** — Slots and openings in the cabinet are provided for ventilation and to ensure reliable operation of the appliance and to protect it from overheating, and these openings must not be blocked or covered. The openings should never be blocked by placing the appliance on a bed, sofa, rug, or other similar surface. The appliance should not be placed in a built-in installation such as a bookcase or rack unless proper ventilation is provided. There should be free space of at least 20 cm (8 in.) and an opening behind the appliance.
- Power Sources** — The appliance should be operated only from the type of power source indicated on the marking label. If you are not sure of the type of power supply to your home, consult your appliance dealer or local power company.
- Grounding or Polarization** — The appliance may be equipped with a polarized alternating current line plug (a plug having one blade wider than the other). This plug will fit into the power outlet only one way. This is a safety feature. If you are unable to insert the plug fully into the outlet, try reversing the plug. If the plug should still fail to fit, contact your electrician to replace your obsolete outlet. Do not defeat the safety purpose of the polarized plug.
- Power-Cord Protection** — Power-supply cords should be routed so that they are not likely to be walked on or pinched by items placed upon or against them, paying particular attention to cords at plugs, convenience receptacles, and the point where they exit from the appliance.

PORTABLE CART WARNING



S3125A

14. **Outdoor Antenna Grounding** — If an outside antenna or cable system is connected to the appliance, be sure the antenna or cable system is grounded so as to provide some protection against voltage surges and built-up static charges. Article 810 of the National Electrical Code, ANSI/NFPA 70, provides information with regard to proper grounding of the mast and supporting structure, grounding of the lead-in wire to an antenna-discharge unit, size of grounding conductors, location of antenna-discharge unit, connection to grounding electrodes, and requirements for the grounding electrode. See FIGURE 1.
15. **Lightning** — For added protection for the appliance during a lightning storm, or when it is left unattended and unused for long periods of time, unplug it from the wall outlet and disconnect the antenna or cable system. This will prevent damage to the appliance due to lightning and power-line surges.
16. **Power Lines** — An outside antenna system should not be located in the vicinity of overhead power lines or other electric light or power circuits, or where it can fall into such power lines or circuits. When installing an outside antenna system, extreme care should be taken to keep from touching such power lines or circuits as contact with them might be fatal.
17. **Overloading** — Do not overload wall outlets, extension cords, or integral convenience receptacles as this can result in a risk of fire or electric shock.
18. **Object and Liquid Entry** — Never push objects of any kind into the appliance through openings as they may touch dangerous voltage points or short-out parts that could result in a fire or electric shock. Never spill liquid of any kind on the appliance.
19. **Servicing** — Do not attempt to service the appliance yourself as opening or removing covers may expose you to dangerous voltage or other hazards. Refer all servicing to qualified service personnel.
20. **Damage Requiring Service** — Unplug the appliance from the wall outlet and refer servicing to qualified service personnel under the following conditions:
 - A. When the power-supply cord or plug is damaged,
 - B. If liquid has been spilled, or objects have fallen into the appliance,
 - C. If the appliance has been exposed to rain or water,
 - D. If the appliance does not operate normally by following the operating instructions. Adjust only those controls that are covered by the operating instructions as an improper adjustment of other controls may result in damage and will often require extensive work by a qualified technician to restore the appliance to its normal operation,
 - E. If the appliance has been dropped or damaged in any way, and
- F. When the appliance exhibits a distinct change in performance — this indicates a need for service.
21. **Replacement Parts** — When replacement parts are required, be sure the service technician has used replacement parts specified by the manufacturer or have the same characteristics as the original part. Unauthorized substitutions may result in fire, electric shock, or other hazards.
22. **Safety Check** — Upon completion of any service or repairs to the appliance, ask the service technician to perform safety checks to determine that the appliance is in proper operation condition.
23. **Wall or Ceiling Mounting** — The appliance should be mounted to a wall or ceiling only as recommended by the manufacturer.
24. **Heat** — The appliance should be situated away from heat sources such as radiators, heat registers, stoves, or other appliances (including amplifiers) that produce heat.
25. **Liquid Hazards** — The appliance should not be exposed to dripping or splashing and no objects filled with liquids, such as vases should be placed on the appliance.

FIGURE 1:
EXAMPLE OF ANTENNA GROUNDING AS PER
NATIONAL ELECTRICAL CODE, ANSI/NFPA 70

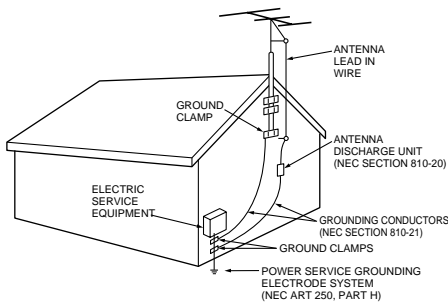

NEC – NATIONAL ELECTRICAL CODE

S2896A

Precautions

For British model

Replacement and mounting of an AC plug on the power supply cord of this unit should be performed only by qualified service personnel.

IMPORTANT

The wires in the mains lead are coloured in accordance with the following code:

Blue: Neutral

Brown: Live

As the colours of the wires in the mains lead of this apparatus may not correspond with the coloured markings identifying the terminals in your plug, proceed as follows:

The wire which is coloured blue must be connected to the terminal which is marked with the letter N or coloured black.

The wire which is coloured brown must be connected to the terminal which is marked with the letter L or coloured red.

IMPORTANT

A 5 ampere fuse is fitted in this plug. Should the fuse need to be replaced, please ensure that the replacement fuse has a rating of 5 amperes and that it is approved by ASTA or BSI to BS1362. Check for the ASTA mark or the BSI mark on the body of the fuse.

IF THE FITTED MOULDED PLUG IS UNSUITABLE FOR THE SOCKET OUTLET IN YOUR HOME THEN THE FUSE SHOULD BE REMOVED AND THE PLUG CUT OFF AND DISPOSED OF SAFELY. THERE IS A DANGER OF SEVERE ELECTRICAL SHOCK IF THE CUT OFF PLUG IS INSERTED INTO ANY 13 AMPERE SOCKET.

If in any doubt, please consult a qualified electrician.

For Canadian model

This class B digital apparatus complies with Canadian ICES-003.

For models having a power cord with a polarized plug:

CAUTION: TO PREVENT ELECTRIC SHOCK, MATCH THE WIDE BLADE OF THE PLUG TO THE WIDE SLOT, THEN FULLY INSERT.

Modèle pour les Canadien

Cet appareil numérique de la classe B est conforme à la norme NMB-003 du Canada.

Sur les modèles dont la fiche est polarisée:

ATTENTION: POUR ÉVITER LES CHOCS ÉLECTRIQUES, INTRODUIRE LA LAME LA PLUS LARGE DE LA FICHE DANS LA BORNE CORRESPONDANTE DE LA PRISE ET POUSSER JUSQU'AU FOND.

For U.S. model

The laser is covered by a housing which prevents exposure during operation or maintenance. However, this product is classified as a Laser Product by CDRH (Center for Devices and Radiological Health) which is a department of the Food and Drug Administration. According to their regulations 21 CFR section 1002.30, all manufacturers who sell Laser Products must maintain records of written communications between the manufacturer, dealers and customers concerning radiation safety. If you have any complaints about instructions or explanations affecting the use of this product, please feel free to write to the address on the back page of this manual. When you write us, please include the model number and serial number of your unit.

In compliance with Federal Regulations, the certification, identification and the period of manufacture are indicated on the rear panel.

FCC INFORMATION FOR USER

CAUTION:

The user changes or modifications not expressly approved by the party responsible for compliance could void the user's authority to operate the equipment.

NOTE:

This equipment has been tested and found to comply with the limits for a Class B digital device, pursuant to Part 15 of the FCC Rules.

These limits are designed to provide reasonable protection against harmful interference in a residential installation. This equipment generates, uses and can radiate radio frequency energy and, if not installed and used in accordance with the instructions, may cause harmful interference to radio communications. However, there is no guarantee that interference will not occur in a particular installation.

If this equipment does cause harmful interference to radio or television reception, which can be determined by turning the equipment off and on, the user is encouraged to try to correct the interference by one or more of the following measures:

- Reorient or relocate the receiving antenna.
- Increase the separation between the equipment and receiver.
- Connect the equipment into an outlet on a circuit different from that to which the receiver is connected.
- Consult the dealer or an experienced radio/TV technician for help.

Note to CATV system installer:

This reminder is provided to call the CATV system installer's attention to Section 820-40 of the NEC which provides guidelines for proper grounding and, in particular, specifies that the cable ground shall be connected to the grounding system of the building, as close to the point of cable entry as practical.

Precautions

DANGER:

VISIBLE AND INVISIBLE LASER RADIATION WHEN OPEN AND INTERLOCK FAILED OR DEFEATED. DO NOT STARE INTO BEAM.

CAUTION:

THIS PRODUCT UTILIZES A LASER. USE OF CONTROLS OR ADJUSTMENTS OR PERFORMANCE OF PROCEDURES OTHER THAN THOSE SPECIFIED HEREIN MAY RESULT IN HAZARDOUS RADIATION EXPOSURE.

This unit contains a semiconductor laser system and is classified as a "CLASS 1 LASER PRODUCT." So, to use this model properly, read this Instruction Manual carefully. In case of any trouble, please contact the store where you purchased the unit. To prevent exposure to the laser beam, do not try to open the enclosure.



In some cases, this label is located on the rear panel. It indicates that:

1. This unit is a CLASS 1 LASER PRODUCT and employs a laser inside the cabinet.
2. To prevent the laser from being exposed, do not remove the cover. Refer servicing to qualified personnel.

1. Regional Restriction Codes (Region Number)

Regional restriction codes are built into DVD AV Controllers and DVD videos for each sales region. If the regional code of the DVD AV Controller does not match one of the regional codes on the DVD video, playback is not possible.

The regional number can be found on the rear panel of the DVD AV Controller (e.g.,  for Region 2).

2. About This Manual

This manual explains the basic procedures for operating the DVD AV Controller. Some DVD videos do not support the full potential of the DVD technology. Your DVD AV Controller may therefore not respond to all operating commands. Refer to instruction notes on discs.

A "⊘" mark may appear on the TV screen during operation. It means that the operation is not permitted by the DVD AV Controller or the disc.

3. Recording Copyright

Recording of copyrighted material for other than personal use is illegal without permission of the copyright holder.

4. AC Fuse

The fuse is located inside the chassis and is not user-serviceable.

If the power does not come on, contact your Onkyo authorized service center.

5. Power

WARNING

BEFORE PLUGGING IN THE UNIT FOR THE FIRST TIME, READ THE FOLLOWING SECTION CAREFULLY.

The voltage of the available power supply differs according to country or region. Be sure that the power supply voltage of the area where the unit will be used meets the required voltage (e.g., AC 120 V 60 Hz or AC 230-240 V 50 Hz) written on the rear panel.

Setting the STANDBY/ON button to standby does not shut off the power completely. So the power cord should be removed from the AC outlet when the unit is not going to be used for a long time.

6. Do not touch the unit with wet hands.

Do not handle the unit or power cord (mains lead) when your hands are wet or damp. If water or any other liquid enters the case, take the unit to an authorized service center for inspection.

7. Location of the unit

- Place the unit in a well-ventilated location. Take special care to provide plenty of ventilation on all sides of the unit especially when it is placed in an audio rack. If ventilation is blocked, the unit may overheat and malfunction.
- Do not expose the unit to direct sunlight or heating units as the unit's internal temperature may rise and shorten the life of the pickup.
- Avoid damp and dusty places and places directly affected by vibrations from the speakers. In particular, avoid placing the unit on or above one of the speakers.
- Be sure the unit is placed in a horizontal position. Never place it on its side or on a slanted surface, as it may malfunction.
- When you place the unit near a TV, radio, or VCR, the playback picture may become poor and the sound may be distorted. In this case, place the unit away from the TV, radio, or VCR.

8. Care

From time to time you should wipe the front and rear panels and the cabinet with a soft cloth. For heavier dirt, dampen a soft cloth in a weak solution of mild detergent and water, wring it out dry, and wipe off the dirt. Following this, dry immediately with a clean cloth. Do not use rough material, thinners, alcohol or other chemical solvents or cloths since these could damage the finish or remove the panel lettering.

Precautions

9. Notes on Handling

- When shipping the unit, use the original shipping carton and packing materials. For maximum protection, repack the unit as it was originally packed at the factory.
- Do not use volatile liquids, such as insect spray, near the unit. Do not leave rubber or plastic products in contact with the unit for a long time. They will leave marks on the finish.
- The top and rear panels of the unit **may become warm after a long period of use. This is not a malfunction.**
- When the unit is not in use, be sure to remove the disc and turn off the power.
- If you do not use the unit for a long period, the unit may not function properly in the future. Turn on and use the unit occasionally.

10. To Obtain a Clear Picture

The unit is a high technology, precision device. If the optical pickup lens and disc drive parts are dirty or worn down, the picture quality becomes poor. To obtain a clear picture, we recommend regular inspection and maintenance (cleaning or parts replacement) every 1,000 hours of use depending on the operating environment. For details, contact your nearest dealer.

11. Notes on Moisture Condensation

Moisture condensation damages the unit.

Please read the following carefully.

- What is moisture condensation?
Moisture condensation occurs, for example, when you pour a cold drink into a glass on a warm day. Drops of water form on the outside of the glass. In the same way, moisture may condense on the optical pick-up lens inside the unit, one of the most crucial internal parts of the unit.
- **Moisture condensation occurs in the following cases.**
 - When you bring the unit directly from a cold place to a warm place.
 - When you use the unit in a room where you just turned on the heater, or a place where cold airflow from an air conditioner directly hits the unit.
 - In summer, when you use the unit in a hot and humid place just after you move the unit from an air conditioned room.
 - When you use the unit in a humid place.
- **Do not use the unit when moisture condensation may occur.** If you use the unit in such a situation, it may damage discs and internal parts. Remove the disc, connect the power cord (mains lead) of the unit to the wall outlet (the mains), turn on the unit, and leave it on for two or three hours. After a few hours, the unit will have warmed up and evaporated any moisture. Keep the unit connected to the wall outlet (the mains) and moisture condensation will seldom occur.

Memory Preservation

This unit does not require memory preservation batteries. A built-in memory power backup system preserves the contents of memory during power failures and even when the power cord is unplugged.

The power cord must be plugged-in to charge the backup system. The memory preservation period after the unit has been turned off varies depending on climate and placement of the unit. On average, memory contents are protected for a period of a few weeks after the time the unit has been turned off. This period is shorter when the unit is exposed to a very humid climate.

Declaration of Conformity

We, ONKYO EUROPE
ELECTRONICS GmbH
LIEGNITZERSTRASSE
6, 82194 GROEBENZELL,
GERMANY



declare in own responsibility, that the ONKYO product described in this instruction manual is in compliance with the corresponding technical standards such as EN60065, EN55013, EN55020 and EN61000-3-2, -3-3.

GROEBENZELL, GERMANY

A handwritten signature in black ink, appearing to read 'I. Mori', is written over a horizontal line.

I. MORI

ONKYO EUROPE ELECTRONICS GmbH

The OSD (On Screen Display) screen shots in this manual were taken with the Language set to English (factory setting).

Features

■ Receiver features

- 5 channels, with 15 watts per channel into 6 ohms (EIAJ)
- 5 channels, with 11 watts per channel into 6 ohms (DIN)
- Subwoofer, 25 watts into 3 ohms (EIAJ)
- Subwoofer, 20 watts into 3 ohms (DIN)
- 96 kHz/24-Bit DAC system
- DTS* & Dolby** digital decoders
- Acoustic control
- 1 digital input/2 outputs
- 3 audio inputs/2 outputs
- S video output
- Theater-Dimensional***
- 30 FM/AM Random presets
- FM Auto Tuning presets
- Sleep timer
- 4 programmable timers
- RDS with PS (European models only)

■ DVD/CD player features

- DTS, Dolby Digital, and PCM compatible
- Component-video output
- Progressive scan (progressive scan-compatible NTSC color TV or monitor required)
- 27 MHz/10-bit video DAC
- Plays DVDs, MP3 CDs, CD-Rs, CD-RWs, video CDs and audio CDs
- High-resolution on-screen display
- Program Memory playback
- Auto Last Play
- Dual-wavelength optical pickup
- Sand-blasted aluminum front panel

■ Other features

- Full-function **RI**-compatible remote control
- Pre-programmed remote controller

* "DTS" and "DTS Digital Surround" are trademarks of Digital Theater Systems, Inc.

** Manufactured under license from Dolby Laboratories.

"Dolby", "Pro Logic" and the double-D symbol are trademarks of Dolby Laboratories.

***"Theater-Dimensional" is a trademark of Onkyo Corporation.

The letter displayed at the end of the product name found in catalogs and on package represents the color of the PDR-155 DVD AV controller. Though the color varies, the specifications and operations are the same.

Speaker care

■ Speaker care

Wipe the cabinet occasionally with a dry silica or soft cloth. For heavier dirt, after dampening a soft cloth in a weak solution of mild detergent and water and wringing it out dry, wipe off the dirt. Then, dry immediately with a clean cloth. Do not use rough material, thinners, alcohol or other chemical solvents or cloths since these could damage the finish, remove the panel lettering, or cause discoloration. If you are using a chemical cloth, always follow the instructions that come with the cloth. For dust accumulated on grilles, use a vacuum cleaner or brush it off.

■ Use with a TV set or computer

In general, Braun tubes used for color television sets and computers are extremely sensitive and can be affected even by the magnetism of the earth. If a speaker system is used near them, therefore, discoloration or distortion of pictures will occur. To allow use with a color television set or computer, this speaker system is provided with magnetic shielding. Even so, discoloration may still result, depending on the installation environment. If discoloration occurs, turn off the power of the television set or computer, wait for 15 to 30 minutes and then turn it on again. This activates the self-demagnetizing function of the television set or computer, improving the display condition.

Note

If discoloration persists even after performing this remedy, move the speaker apart from the television set or computer. Discoloration may also be caused when a magnet or other magnetizing object exists near the television or computer because of the combined effect.

■ Precaution on use

This speaker system can handle the specified input power when it is used for ordinary music reproduction. If the following abnormal signals are fed to the speaker, however, an overcurrent may flow in the internal circuits, causing burning or breakage of the wires even if the input power is below the specified rating.

1. Noise produced when FM station is not tuned in
2. Sound produced when fast-forwarding cassette tape deck
3. High-frequency sound generated by an oscillator, an electronic musical instruments, etc.
4. Oscillating amplifier signals
5. Special test signals produced by audio checking CD, etc.
6. Sound produced when connecting or disconnecting audio connection cables (Always turn off the amplifier's power before connecting or disconnecting cables.)
7. Howling when a microphone is used

Note:

The L-DR7 DVD Theater System performance is optimized when the subwoofer (SWA-155X), speakers (D-M7 and D-M3), and DVD AV controller (PDR-155) are used. Onkyo is not responsible for malfunctions caused by using speakers or receivers from other manufacturers.





■ About memory preservation

The PDR-155 has an auxiliary power source to preserve memory and prevent settings from being erased during power outage. The PDR-155 preserves memory for about two weeks with the power cable disconnected. However, the clock and timer settings are cancelled.

Handling Discs

Playable discs

The PDR-155 can only play back discs with the following marks on the disc labels, packaging, or jackets.

Disc mark				
DVD videos	VIDEO CDs	CD ^{*1}	CD-R ^{*2}	CD-RW ^{*2}
				

*1 About playing copy-controlled CDs

Some copy-controlled CDs may not conform to official CD standards. They are special discs and may not play on the PDR-155.

*2 About playing CD-R/CD-RW discs

This unit can play CD-R and CD-RW discs recorded in CD Audio or Video CD formats, as well as discs that contain MP3 audio files. However, there may be some discs that cannot be played back with this unit. This limitation may be due to incomplete disc finalization; the characteristics of the recorder; disc characteristics, damage, or stains; or condensation or stains on the pickup lens of this unit. For details, please refer to the recorder's instruction manual.

■ Non-playable discs



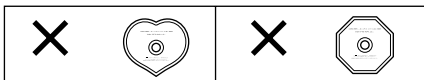

- You cannot play back discs other than those listed above.
- You cannot play discs such as CD-ROM, DVD-RAM, DVD-RW, DVD-Audio, Photo CD, CD-G etc., even if the marks in the above table are labeled on those discs.
- The PDR-155 uses the PAL/NTSC color system, and cannot play back DVD videos recorded in any other color system (SECAM, etc.).
- Avoid using heart-shaped or octagonal discs. Playing irregularly-shaped discs may damage the internal mechanism of the DVD AV Controller.



- Do not use discs that have residue from adhesive tape, rental discs that have peeling labels, or discs that have custom labels or stickers. Otherwise, you may not be able to eject the discs, or the DVD AV Controller may become inoperative.

DVD disc icons:

You may see the following icons on DVD disc labels or packages:

Icon	Description
	The number of audio tracks
	The number of subtitle languages
	The number of camera angles
	Aspect ratio of video
	Region numbers

Some DVD videos specify a region number, which is used to limit the area where the videos can be viewed.

If you try to play a disc with a region number other than those listed on PDR-155's rear panel, the system will display the message "Wrong Region No.," indicating that the disc cannot be played.

Handling Discs

DVD control limitations

The controls on certain DVD discs may be prohibited or disabled. The PDR-155 will display an icon (🚫) that means a function is “prohibited by the disc” if you try to execute such a function.

On discs that enable interactive controls from the menu or during playback, certain functions (such as repeat play or programming) may not be available. In these cases, the PDR-155 will display an icon (🚫) that means the function is “prohibited by the player.”

About video CDs

This DVD AV Controller supports Video CDs with or without PBC (Version 2.0). (PBC is an abbreviation for Playback Control.)

- **Video CDs without PBC (Version 1.1)**

Video CDs that do not utilize PBC allow you to play sound and movies on the PDR-155 using the same operations you would use to play an audio CD.

- **Video CDs with PBC (Version 2.0)**

Video CDs that utilize PBC also allow you to play sound and movies on the PDR-155. In addition, these discs enable you to use interactive software and search functions from a menu displayed on the TV screen (Menu Playback). Some of the functions described in this Instruction Manual may not work with some discs.

MP3 compatibility information

- The CD-ROM must be ISO9660-compatible.
- Files should be in the MPEG1 Audio Layer 3 format, 44.1 or 48 kHz, fixed bit rate. Incompatible files will not play and the system will display “UNPLAYABLE.”
- The PDR-155 plays only tracks that use the file extension “.mp3” or “.MP3”.
- Use CD-R or CD-RW media to record your MP3 files.
- The disc must be finalized to play properly.
- Audio encoded at 128kbps should sound nearly as good as standard audio CDs. Although the PDR-155 will play MP3 tracks encoded at lower bit rates, the audio quality is noticeably worse.
- Only the first eight characters of a folder or track name (excluding the “.mp3” extension) are displayed.
- The PDR-155 can recognize a maximum of 250 folders and 250 tracks. Folders and tracks in excess of 250 will not play.
- **The PDR-155 is not compatible with variable bit rate (VBR) files. Be sure to create MP3 CDs with a fixed bit rate.**
- **The PDR-155 is not compatible with multi-session discs. If you try to play a multi-session disc, the PDR-155 will play only the first session.**

Handling Discs

Differences in disc composition

■ DVDs

All discs are divided into smaller, more manageable sections so that you can find specific content more easily.

More specifically, discs are divided into one or more titles. Each title may be further divided into several chapters. Occasionally, a chapter may contain index points, effectively dividing the chapter into several parts as well.

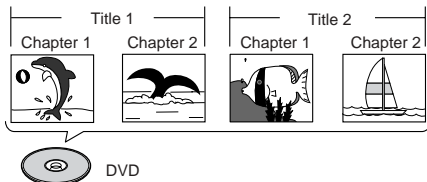

■ Video CDs and audio CDs

Video CDs and audio CDs are divided into a number of tracks. In rare cases, a track may contain a number of index points, effectively dividing the track into several parts.

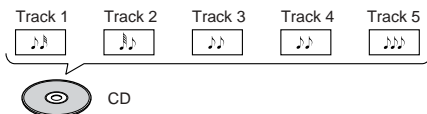
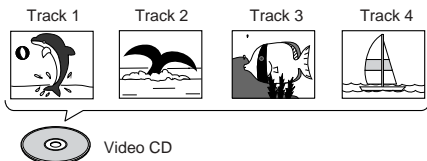

■ MP3

MP3 (MPEG1 Audio Layer 3) is a compressed audio file format. Files are recognized by their file extension ".mp3" or ".MP3". Folders that contain MP3 files are automatically numbered F_001, F_002, etc. Tracks within folders are automatically numbered T_001, T_002, etc.

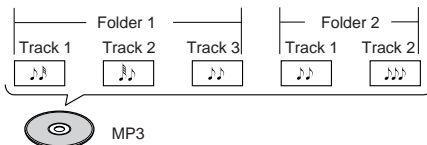

Handling Discs

Handling discs

- Do not touch the playback side of a disc.

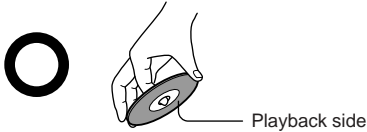

- Do not attach paper or tape to discs.

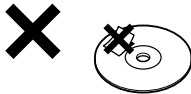

Cleaning discs

- Fingerprints and dust on a disc can cause picture and sound deterioration. Wipe the disc from the center outwards with a soft cloth. Always keep discs clean.

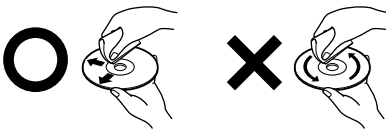

- If you cannot wipe off the dust with a soft cloth, wipe the disc lightly with a slightly moistened soft cloth and finish with a dry cloth.
- Do not use any type of solvent, such as thinner, benzene, commercial cleaners or antistatic spray for vinyl LPs. These solvents may damage discs.

Storing discs

- Do not store discs in locations subject to direct sunlight or near heat sources.
- Do not store discs in locations subject to moisture or dust, such as a bathroom or near a humidifier.
- Store discs in cases. Store each case vertically. Stacking or placing objects directly on a disc may cause it to warp.

Copyrights

It is forbidden by law to copy, broadcast, show, broadcast on cable, play in public, or rent copyrighted material without permission.

DVD videos are copy-protected, and any recordings made from these discs will be distorted.

This product incorporates copyright protection technology that is protected by method claims of certain U.S. patents and other intellectual property rights owned by Macrovision Corporation and other rights owners. Use of this copyright-protection technology must be authorized by Macrovision Corporation, and is intended for home and other limited viewing uses only, unless otherwise authorized by Macrovision Corporation. Reverse engineering or disassembly is prohibited.

Supplied Accessories

Make sure your box contains everything listed below.
If any pieces are missing, contact the nearest Onkyo service station.
The number of each item indicated in brackets.

DVD AV CONTROLLER PDR-155

- DVD AV Controller (PDR-155) [1]

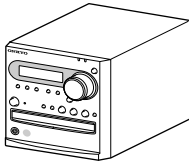

- Remote controller (RC-506M) [1]
Batteries (size AA/R6) [2]



- AM indoor antenna [1]
Receives AM radio signals.



- FM indoor antenna [1]
Receives FM radio signals.
 - The shape may vary depending on the area which it was purchased.

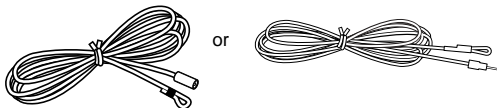

- FM outdoor antenna (aerial) adapter [1]
(Not supplied for European models)

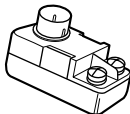

- Multi-splitter cable [1]
Connects the PDR-155 and SWA-155X.

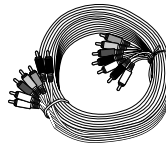

- S video connection cable [1]
Transmits S video data.



- Audio/video connection cable [1]
Yellow= video, red & white = audio

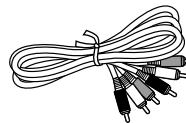

- Power cable [1]
- Instruction Manual (this manual)

Supplied Accessories

SPEAKER SYSTEM HTP-L7

- Subwoofer (SWA-155X) [1]

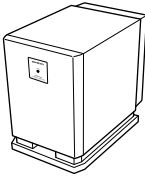

- Speaker installation brackets [5] and screws [5]

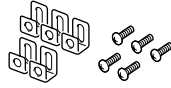

- Speakers (D-M7) [2]

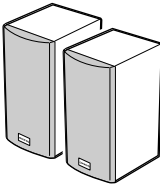

- Speakers (D-M3) [3]

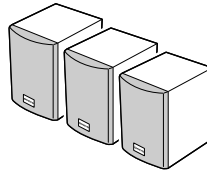

- Subwoofer cork spacers [1set (4 pieces)]
To be attached to the bottom of the subwoofer.

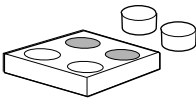

- Speaker cork spacers [1set (20 pieces)]
To be attached to the bottom of the speakers.

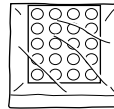

- Speaker cords (for surround) 8 m [2]



- Speaker cords (for left/right front, and center) 2.5 m [3]



Supplied Accessories

■ Using the included cork spacers and installation brackets

• Cork spacer for the subwoofer (SWA-155X)

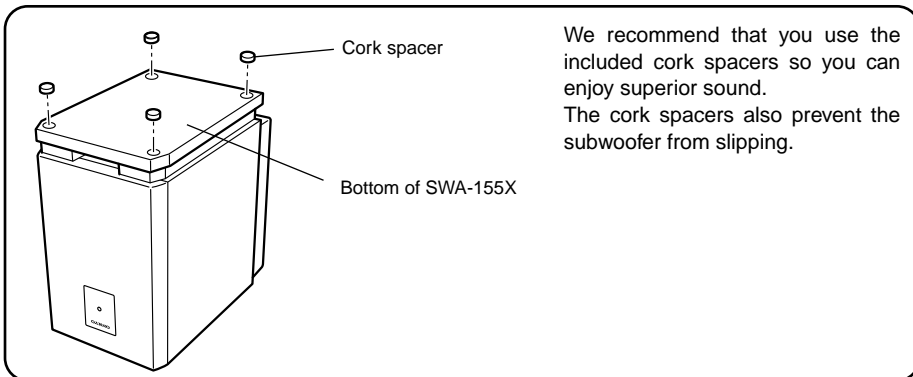

• Cork spacers for the speakers (D-M7, D-M3) (The illustrations below indicate the D-M7 speaker.)

We recommend that you use the included cork spacers so you can enjoy superior sound. The cork spacers also prevent the speakers from slipping.

Positioning vertically

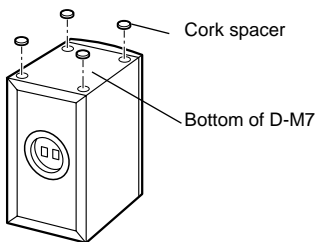

Positioning horizontally

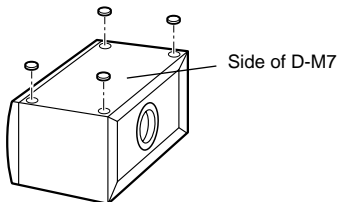

Mounting on a wall

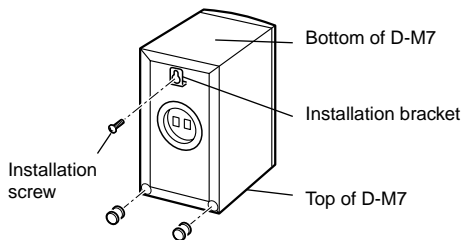

Wall-mount the speakers upside down. Layer two spacers and attach them to two locations. The plaques rotate so that you can position the speakers upside down.

Attaching the brackets:

Use the included screws to attach the brackets to the back of the speakers.

Caution:

Before you mount the speakers on a wall, check the strength of the wall. The supporting strength of the screws varies depending on the wall material and the position of the studs. Use screws as thick and long as possible, with a head diameter of 10 mm or less and a thread diameter of 4 mm or less. (We recommend that you consult a professional home electronics installer.)

Preparing the Remote Controller

Inserting the batteries

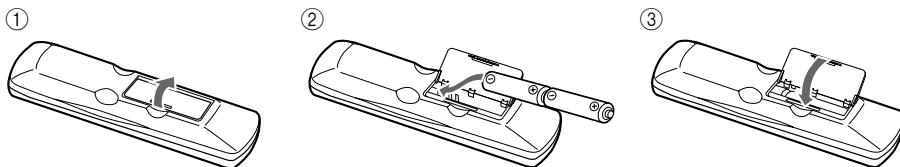

① **Detach the battery cover.**

② **Insert two size-AA/R6 batteries.**

Be sure to match the + and - ends of the batteries with the diagram inside the battery compartment.

③ **Attach the battery cover.**

- Do not mix new batteries with old batteries or different kinds of batteries.
- To avoid corrosion, remove the batteries if you do not intend to use the remote controller for a long time.
- Remove dead batteries immediately to avoid damage from corrosion. If the remote controller does not operate smoothly, replace both batteries at the same time.
- The life of the supplied batteries is about six months, but this varies with usage.

Using the remote controller

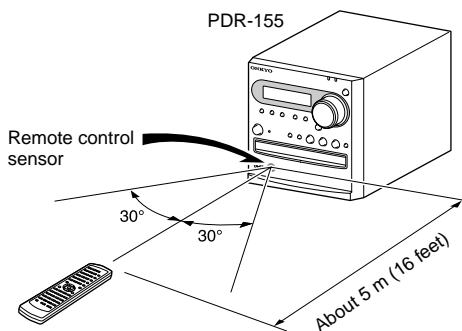

Point the remote controller toward the remote control sensor.

- Place the unit away from strong light, such as direct sunlight or inverted fluorescent light, which can prevent proper operation of the remote controller.
- Using another remote controller of the same type in the same room or using the unit near equipment that uses infrared rays may cause operational interference.
- Do not put any object (such as a book) on the remote controller. The buttons of the remote controller may be pressed by mistake, which drains the batteries.
- Make sure the audio rack doors do not have colored glass. Placing the unit behind such doors may prevent proper remote controller operation.
- If there is an obstacle between the remote controller and the remote control sensor, the remote controller will not operate.

Index to Parts and Controls

For operational instructions, refer to the pages indicated in brackets.

Front panel

STANDBY/ON button

Turns on the power to the PDR-155 or places the unit in Standby mode.

STANDBY indicator
Lights up in Standby mode.

SURROUND MODE button

Selects a surround mode.

PROGRESSIVE SCAN/

Lights up when [Component Video] is set to [Progressive]. (progressive scan-compatible NTSC color TV or monitor required).

T-D (Theater-Dimensional) indicator

Lights up in Theater-Dimensional surround mode.

T-D/STEREO button (page 72)

Display (page 20)

PRESET MEMORY button
Assigns the radio station.

INPUT ◀▶ buttons

Selects an input source other than DVD.

MUTING button
Mutes the sound temporarily.

MASTER VOLUME control
Adjusts the sound level.

ACOUSTIC CONTROL button
Boosts the super bass/high range sound

Disc tray

To load a disc, place the disc in the disc tray with its label side facing up.

PHONES jack

This is a standard stereo jack for connecting stereo headphones. (page 47)

Remote control sensor

Point the remote controller toward the remote sensor to operate the PDR-155. (page 18)

▲ button
Opens and closes the disc tray.

⏏ button
Press once to pause playback. Press again to resume playback.

▶ button
Starts or resumes playback.

■ button
Stops playback.

◀◀/▶▶, ◀TUNING PRESET▶ buttons

Locate a point or the top of a track. Alternatively, they select preset channels and set the tuning frequency.

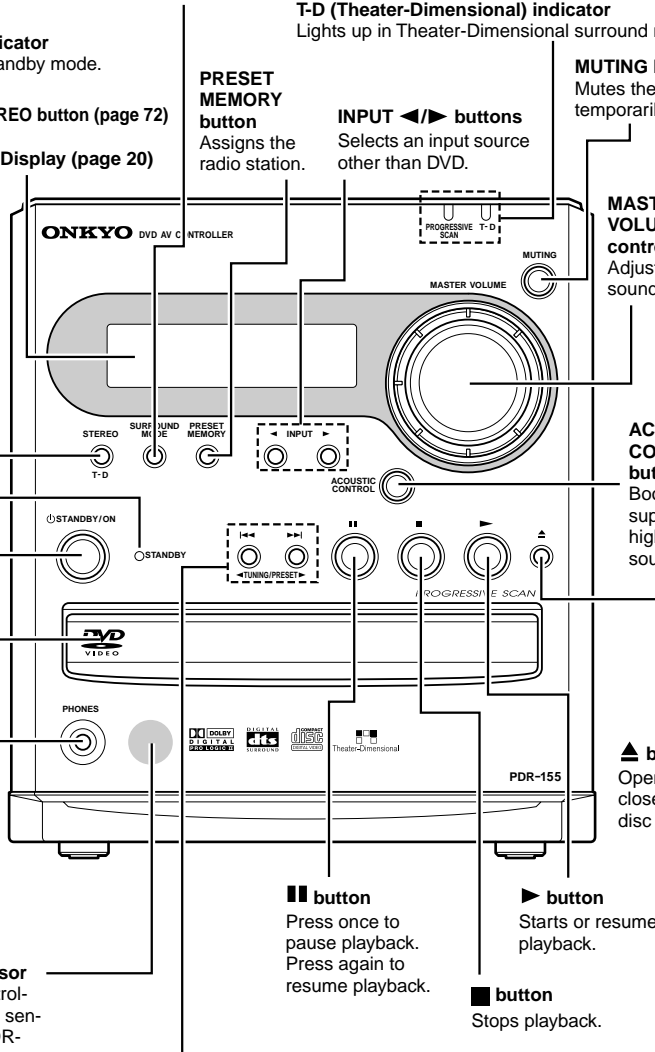

Depending on the country in which you purchased your controller, the logos printed on the front panel may be different to those shown here.

Index to Parts and Controls

Display

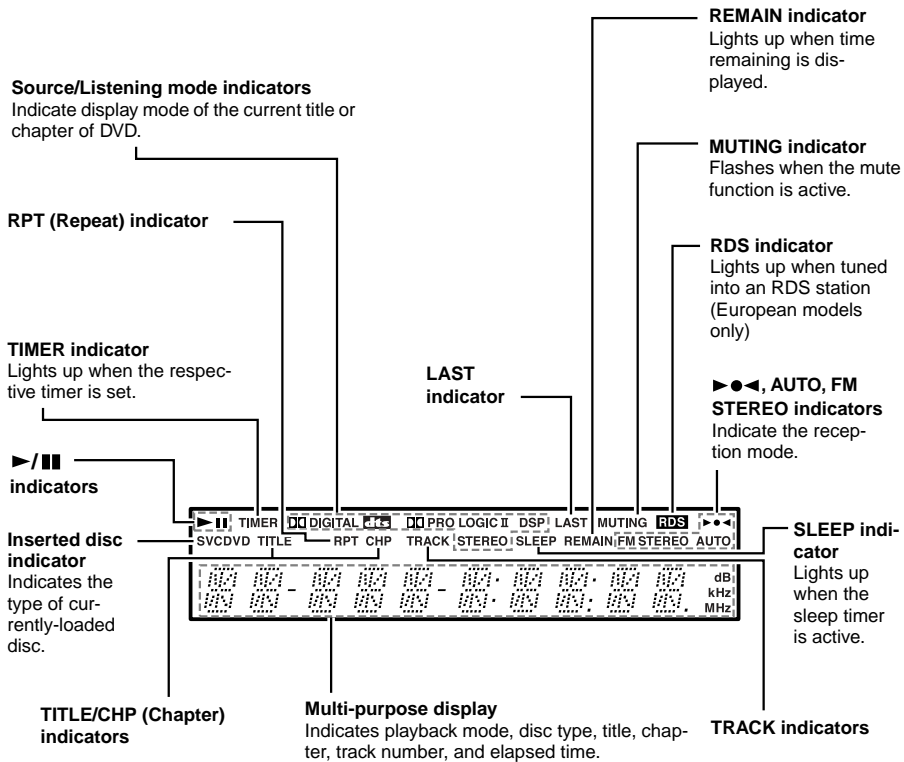

Index to Parts and Controls

Rear panel

MD/TAPE IN/OUT jacks

Connect these jacks to the MD recorder or tape deck's audio input/output jacks, using optional audio pin cables.

TV/LINE IN jacks

Connect these jacks to the TV's audio output jacks, using the included audio video pin cable.

S VIDEO output jack

S video signal is output from this jack. Connect this to the TV's S video jack, using the included S video cable.

CDR/VIDEO IN/OUT jacks

Connect these jacks to the CD recorder or video deck's audio input and output jacks, using optional audio pin cables.

MULTI CH OUTPUT jacks

Use the included multi-splitter cable to connect these jacks to the SWA-155X (subwoofer) MULTI CH INPUT jacks.

SUBWOOFER CONTROL jack

Connect this jack to the SWA-155X (subwoofer) SUBWOOFER CONTROL jack, using the included multi-splitter cable.

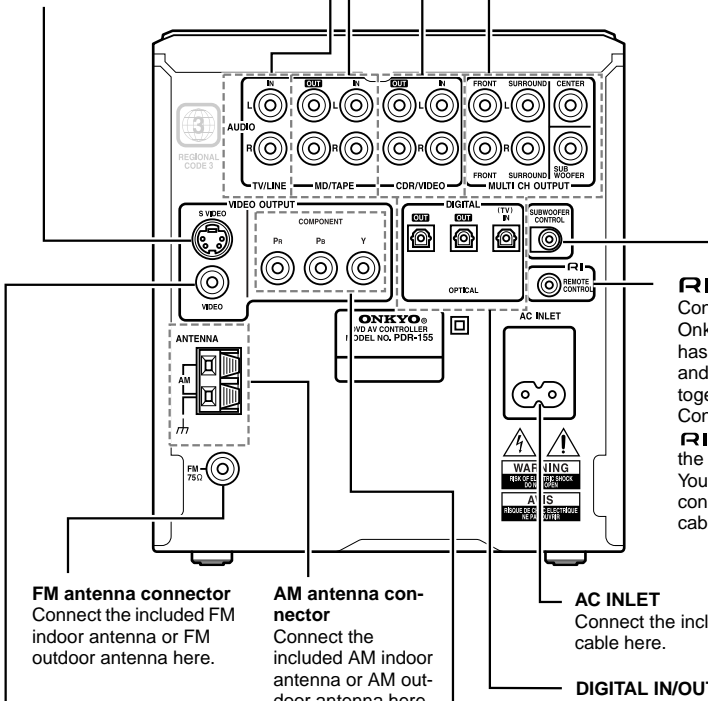

RI jack

Connect this jack to an Onkyo component that has an RI jack to link and control them together. Connecting only the RI cable does not link the system completely. You will also need to connect audio pin cables.

FM antenna connector

Connect the included FM indoor antenna or FM outdoor antenna here.

AM antenna connector

Connect the included AM indoor antenna or AM outdoor antenna here.

AC INLET

Connect the included power cable here.

VIDEO output jack

Video signal is output from this jack. Connect this jack to a TV, using the included audio/video connection cable.

COMPONENT jacks

Video signal is output from these jacks. Connect these jacks to the TV's component jacks.

DIGITAL IN/OUT jacks (OPTICAL)

Connect these jacks to the MD recorder or CD recorder's digital IN jacks, using an optional optical digital audio cable. Do not connect a component to both IN and OUT jacks at the same time.

Index to Parts and Controls

Subwoofer SWA-155X (front panel)

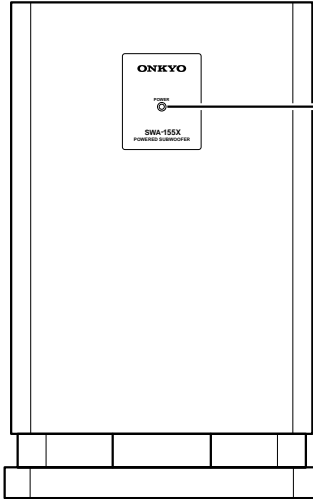

POWER indicator
Lights up green when the power is turned on.

Subwoofer SWA-155X (rear panel)

Cooling fan
This fan starts rotating when the output exceeds a certain threshold to release the heat inside the subwoofer.

FRONT SPEAKERS connectors
Connect the D-M7 front L/R speakers to the L/R connectors and the D-M3 center speaker to the C connector.

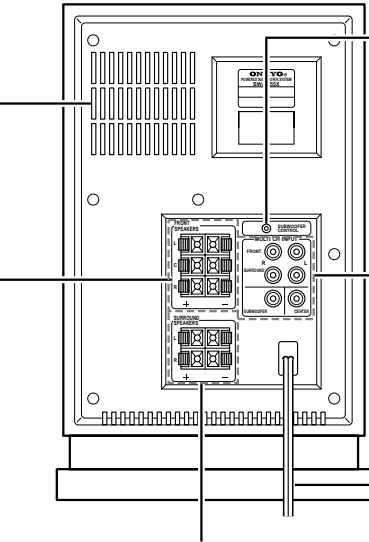

SUBWOOFER CONTROL jack
Connect this jack to the PDR-155 SUBWOOFER CONTROL jack.

MULTI CH INPUT jacks
Connect these jacks to the PDR-155 MULTI CH OUTPUT jacks.

Power cable

SURROUND SPEAKERS connectors
Connect the D-M3 left/right surround speakers here.

Index to Parts and Controls

Remote controller

ON button

Press once to turn on the power to the PDR-155.
Press again to turn on the power to the connected **RI** components.

STANDBY button

Places the PDR-155 in standby mode.

INPUT SELECTOR \leftarrow/\rightarrow buttons

Selects the input source.

SHIFT button

For 10 seconds after you press the button, you can access the functions of the labels printed above some buttons.

REPEAT button

DVD, CDR, MD: Starts repeat playback.
TAPE: Switches between Normal and Reverse modes.

A-B button

DVD, MD: Starts A-B repeat playback.

- MODE** CDR, MD: Switches among Program, Random, and Normal playback.
FM, AM: Switches between Auto and Mono.
- $\leftarrow \parallel$ CDR, MD: Pauses disc playback.
TAPE: Plays back the B side.
- \blacksquare CDR, MD, TAPE: Stops playback.
- \blacktriangleright CDR, MD: Starts or resumes playback.
TAPE: Plays back the A side.

DIMMER button

Adjusts the brightness of the front display.

SLEEP button

Sets the sleep timer.

MUTING button

Activates the mute function.

RECEIVER button

Makes the functions indicated by the labels printed on some buttons accessible.

TV/SETUP button

Makes the functions of the labels printed below some buttons accessible.

ACOUSTIC CONTROL button
Changes the acoustic mode to boost the super bass/high frequency sounds.

SEARCH button

DVD: Selects the type of search.

PROGRAM button

Enables you to set Program playback.

CLEAR button

DVD: Cancels the setting.

TIMER button

Activates a timer function or enables timer programming.

STEP/SLOW buttons

DVD: Steps through frames or plays back at slow speeds.

- \blacksquare DVD: Stops playback.
- \blacktriangleright DVD: Starts or resumes playback.
- \parallel DVD: Pauses disc playback.
- $\leftarrow \blacktriangleright$ DVD, CDR, MD: Fast forward/fast backward.
FM, AM: Adjusts the frequency.
- $\leftarrow \blacktriangleright \parallel$ DVD, CDR, MD, TAPE: Locates the top of scenes or tracks.
FM, AM: Selects a preset station.

DISPLAY button

Changes the information being displayed.

CLOCK button

Displays the current time.

VOLUME $\blacktriangle/\blacktriangledown$ buttons

Adjusts the volume.

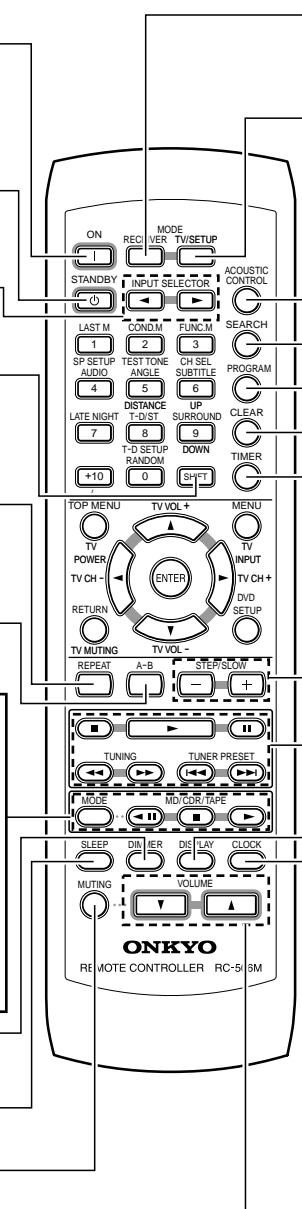

Index to Parts and Controls

■ Name and function of the remote controller (RC-506M) buttons

The remote controller (RC-506M) that comes with the PDR-155 features various functions on its compact body. To perform certain operations, you first need to press one of the following buttons to change the mode before pressing other buttons.

RECEIVER button DVD operation mode

TV/SETUP button..... Home theater and TV operation mode

SHIFT button..... DVD special function mode (Press **SHIFT**, then press other buttons within 10 seconds.)

Press the RECEIVER button first to use these buttons.

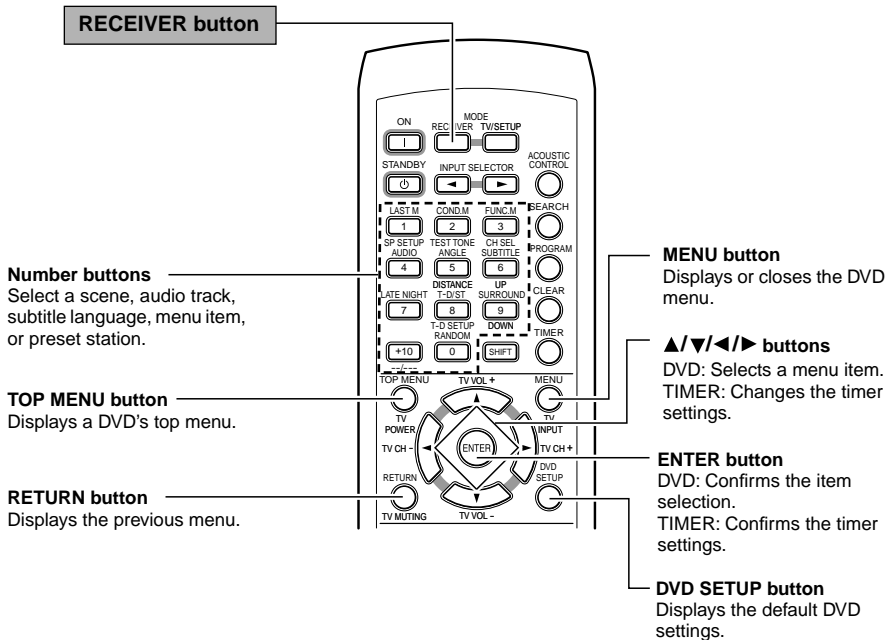

Index to Parts and Controls

Press TV/SETUP to use these buttons (blue labels)

TEST TONE button

Outputs a test tone for setting speaker levels.

SP SETUP button

Press to select the optimum speaker configuration.

UP button

Selects a distance or level.

DISTANCE button

Sets a distance for each speaker.

DOWN button

Selects a distance or level.

T-D SETUP button

Sets the angles between the front speakers and the viewing/listening position.

TV/SETUP button

CH SEL button

Selects a speaker for changing its output level.

TV operation buttons

To use these buttons, you need to program the TV's remote control code. Refer to page 119 for more information.

TV POWER button

Turns on the TV.

TV MUTING button

Mutes the TV volume.

TV CH +/- buttons

Selects a TV channel.

TV VOL +/- buttons

Adjusts the TV volume.

TV INPUT button

Selects the TV input.

When you press the SHIFT button on the remote controller, the following functions become accessible for 10 seconds.

LAST M button

DVD: Memorizes the point at which to resume playback.

AUDIO button

DVD: Changes the audio language.

LATE NIGHT button

Changes the dynamic range for lower listening volume.

T-D/ST button

Switches the listening mode between "Stereo" and "Theater-Dimensional."

RANDOM button

Starts Random playback.

FUNC. M button

DVD: Registers the items for which you frequently change the setting.

COND. M button

DVD: Memorizes the default settings.

SUBTITLE button

DVD: Selects the subtitle language.

ANGLE button

DVD: Selects the camera angle.

SURROUND button

Selects the surround mode.

SHIFT button

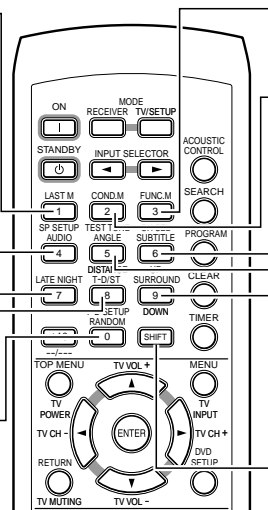
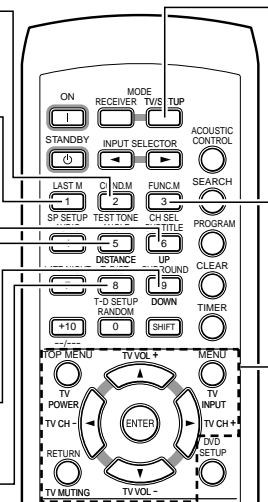

What is Home Theater?

■ Enjoying home theater

The L-DR7 creates a three-dimensional audio experience by moving and panning sound among multiple speakers. This enables you to enjoy the atmosphere and acoustics of theaters and concert halls (i.e., 5.1 channel surround playback) while you relax at home.

Two D-M7 speakers serve as the left and right front speakers; one D-M3 speaker serves as the center speaker; and two D-M3 speakers serve as the left and right surround speakers.

Depending on the audio-encoding of a particular DVD disc, you can enjoy DTS or Dolby Digital playback. You can also enjoy Onkyo's proprietary DSP surround sound for TV or MD playback (see page 71).

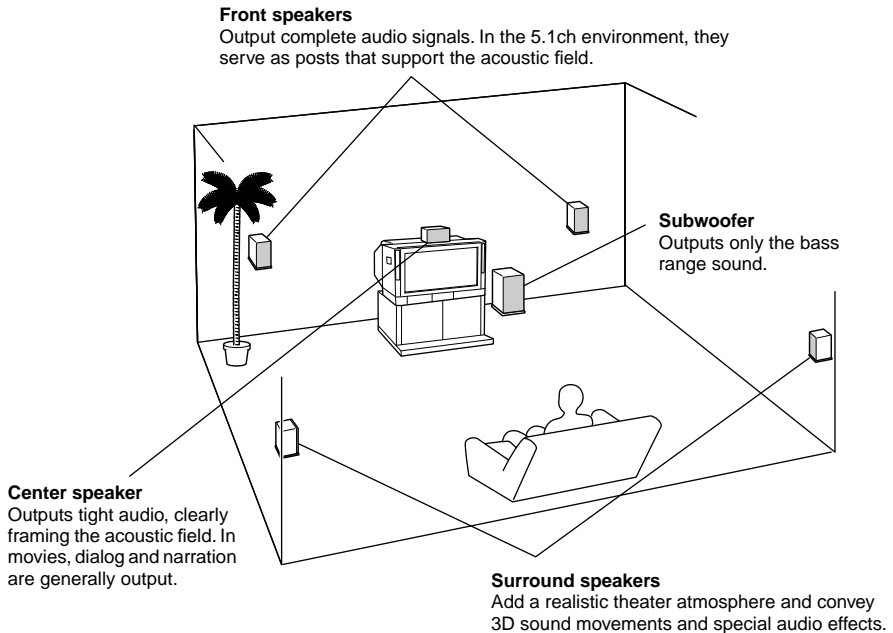

Connecting the L-DR7

- Connect the DVD AV Controller (PDR-155) and the subwoofer (SWA-155X) (page 29).
- Connect the subwoofer (SWA-155X) and the speakers (D-M7, D-M3) (page 30).
- Connect your MD recorder or CD recorder to the PDR-155 to play an MD or CD in a 5.1ch environment.

Positioning the speakers

Refer to the explanation of each speaker's role and the speaker position examples (page 31).

Setting up the speakers

To enjoy optimal surround sound, set up the speakers correctly (page 76).

Connections

Connecting the PDR-155 to a TV

Connecting a video signal

To connect a video signal, you can use the COMPONENT jacks, S VIDEO IN connector, or VIDEO IN jack.

Select a connection to match the input connectors on your TV.

- Refer to the instruction manual for the TV you are connecting.
- Before you connect a TV, turn off the power and unplug the TV.
- Do not connect the power cable of the PDR-155.
- Connect the PDR-155 directly to the TV. If you connect a VCR between them, images from VCR tapes may look distorted.
- Insert the cable plugs completely.

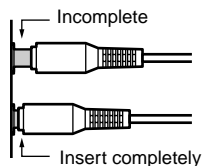

If the TV has component jacks:

Component jack connection provides a better image than an S video connection.

Tip:

Component video outputs also allow you to enjoy the improved picture quality offered by progressive scanning. (progressive scan-compatible NTSC color TV or monitor required.)

If the TV has an S video connector:

Use the included S video cable to make an S video connection. This connection offers better image quality than the VIDEO IN jack.

If the TV has neither component jacks nor an S video connector:

Use the included yellow pin cable to make a VIDEO IN connection.

Audio connection

To listen to TV audio, you need to connect the audio output of a TV or satellite tuner to the PDR-155 TV/LINE IN jack.

If your TV or satellite tuner has digital output, connect it to the PDR-155 DIGITAL IN jack to listen to digital audio.

Digital audio has priority when both digital and analog jacks are connected.

Connections

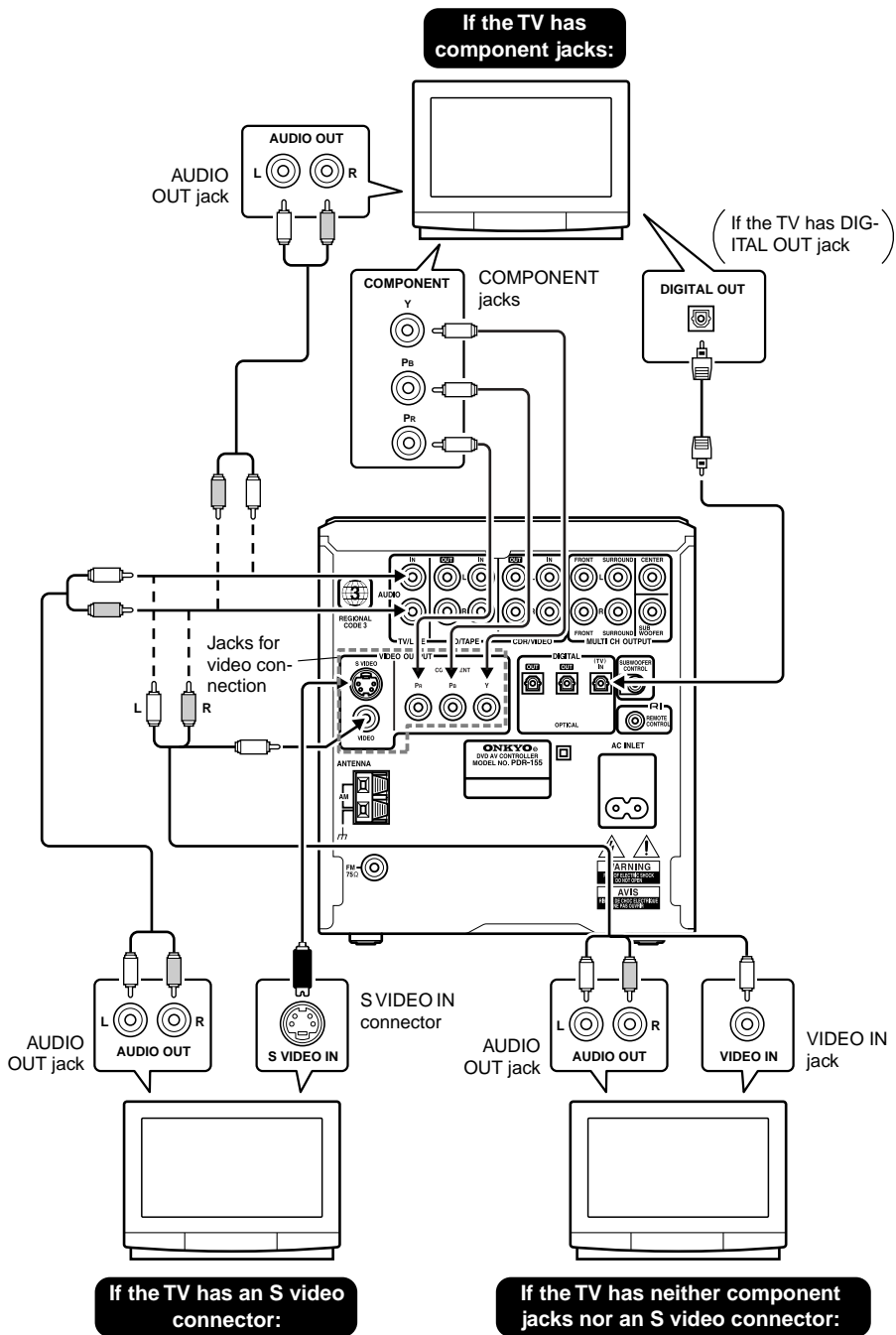

Connections

Connecting the DVD AV controller (PDR-155) and the subwoofer (SWA-155X)

Refer to the diagram below to connect the jacks using the included multi-splitter cable. Do not connect the power plug yet.

 : signal flow

SWA-155X

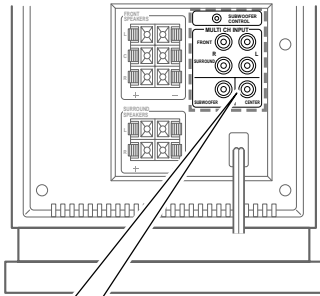

PDR-155

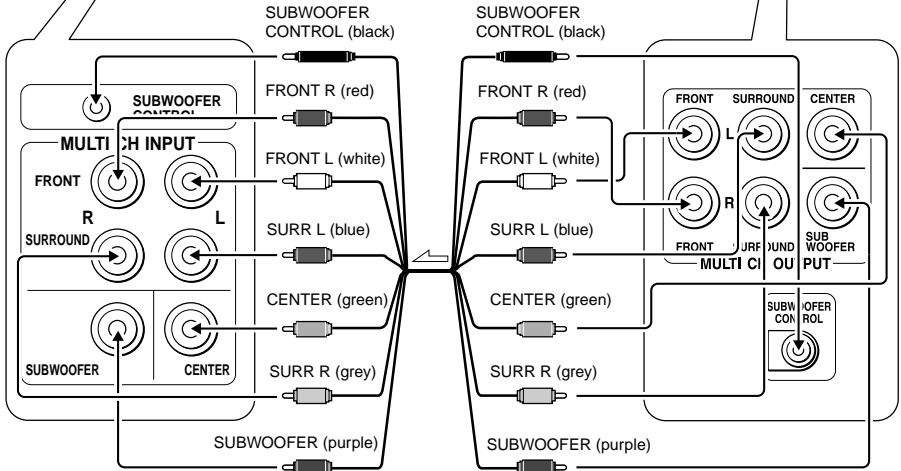
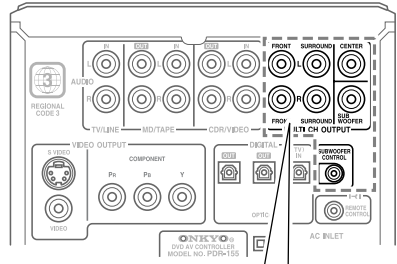

To SWA-155X's MULTI CH INPUT jack

To PDR-155's MULTI CH OUTPUT jack

- Plug in all cables completely. Otherwise, noise or malfunction may occur.
- Do not bundle the multi-splitter cable with the speaker cords. Otherwise, tonal quality may deteriorate.

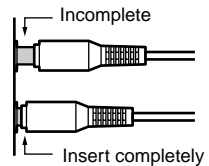

Connections

Connecting the subwoofer (SWA-155X) and the speakers (D-M7, D-M3)

■ Before connecting the speakers

Prepare the included speaker cords as follows:

① Remove the tip of the plastic shield of the speaker cords.



② Twist the core wires.

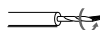

■ Connecting the front, center, and surround speakers

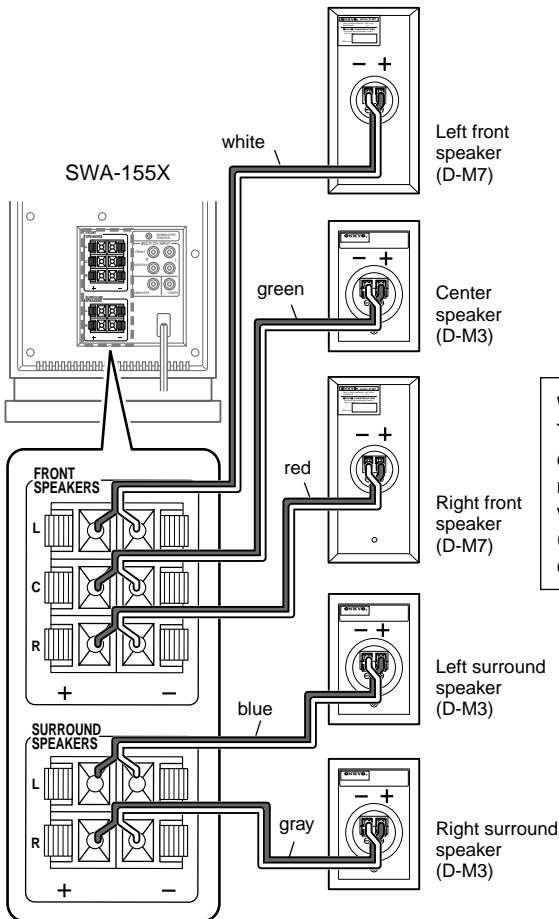

Connecting the cords to the speaker connectors:

① Press the lever.

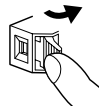

② Insert the core wires into the slot.

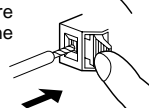

③ Release the lever.



WARNING!

To prevent any circuit malfunction, do not let the core wires of the + and - (or L and R) cords contact each other.

NO



- Connect the speaker's "+" connector to the subwoofer's "+" connector, and the speaker's "-" connector to the subwoofer's "-" connector using the color-coded speaker cords.
- Connect the colored speaker cords to the "+" connectors.
- If you connect the cords to the wrong connectors ("+" to "-") or connect the speakers to the wrong channels (L to R), the audio will sound unnatural.

Connections

■ Basic positioning example and the role of each speaker

Although recommended speaker positions vary depending on the room size and wall material, this section offers a basic positioning example and explains the function of each speaker.

Even if you cannot precisely follow the example below, you can still enjoy optimal surround sound by specifying the distance from the listener to the speakers (page 76). You can also adjust the volume level of each speaker to suit your preference (page 77). (Make these settings after all connections are completed.)

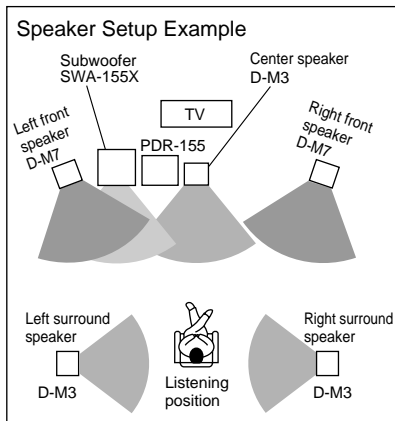

Using optional speaker stands or brackets

Each satellite speaker has one M5 screw hole on the back, and two 60 mm M5 screw holes on the bottom. To secure the bottom surface, use optional stands or brackets.

If you use a stand or brackets, use M5 screws with an effective screw length of 7–12 mm, depending on the thickness of the stand.

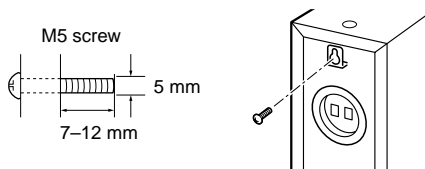

Center speaker

Place the center speaker as close as possible to the screen and position it so that the sound is directed at the listener's ears.

The center speaker enriches the sound image by framing the sound effects and panning sound output from the left and right front speakers. In movies, generally, dialog and narration are output from this speaker.

Left and right front speakers

Place the front speakers in front of the listener.

- Position the speakers at the same height as the center speaker.
- Position the speakers so that the audio will be directed at the listener's ears. It is recommended that you place the speakers symmetrically.

Surround speakers

Place the surround speakers to the sides or rear of the listener.

The surround speakers enhance the atmosphere of theaters or halls by conveying the three-dimensional movement of sound and re-producing environmental sounds (that represent the background) and special effect sounds (for example, that bring a scene to a climax).

Subwoofer

Place the subwoofer near the front speakers.

The subwoofer has a great advantage in producing powerful, super bass effects. Only low-range sound is output.

Caution:

Do not place the satellite speakers on the edge of a desk or rack. Otherwise, they may fall, causing injury.

Connections

Connecting the DVD AV controller (PDR-155) to other components

■ Connecting an MD recorder or tape deck (MD/TAPE IN/OUT jacks)

You can connect these jacks to the audio input/output of an MD recorder or tape deck.

If you have connected an Onkyo component that has an **RI** jack, set the input indication (INPUT) correctly.

Connecting an Onkyo Separate Collection Series MD recorder or tape deck:

Connect the PDR-155's MD/TAPE AUDIO IN jacks, and the MD-101A's ANALOG OUTPUT or K-501A's OUTPUT jacks.

Connect the PDR-155's MD/TAPE AUDIO OUT jacks, and MD-101A's ANALOG INPUT or K-501A's INPUT jacks.

Do not place the MD recorder on top of the PDR-155.

Note that the available components may vary depending on the area.

Connecting other MD recorder or tape deck models

Connect the analog audio output jacks of an MD recorder or tape deck to the PDR-155's MD/TAPE AUDIO IN jacks.

Connect the analog audio input jacks of an MD recorder or tape deck to the PDR-155's MD/TAPE AUDIO OUT jacks.

Digital recording from the PDR-155 to an MD recorder

Use an optical digital cable to connect the PDR-155's DIGITAL OUT jack to a digital audio input jack on the MD recorder. If you are using the MD-101A, use its DIGITAL INPUT 1 jack.

- Be sure to insert the cable plugs completely into the jacks. If the connection is incomplete, noise or malfunction may occur.
- Do not bundle the audio pin cables with the power cable and/or speaker cords. Otherwise, tonal quality may deteriorate.
- When you use an optical audio digital cable, do not bend or coil it tightly. Otherwise, noise or malfunction may occur.
- After all connections are completed, insert the power cable plug into the appropriate AC outlet (page 40).
- The DIGITAL jack has a protective cap installed. When you use this jack, remove the cap. When you are not using this jack, be sure to replace the cap.

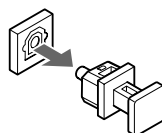
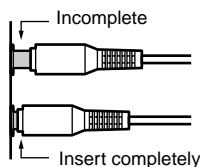

Connections

Connecting the PDR-155 to an MD recorder (MD-101A)

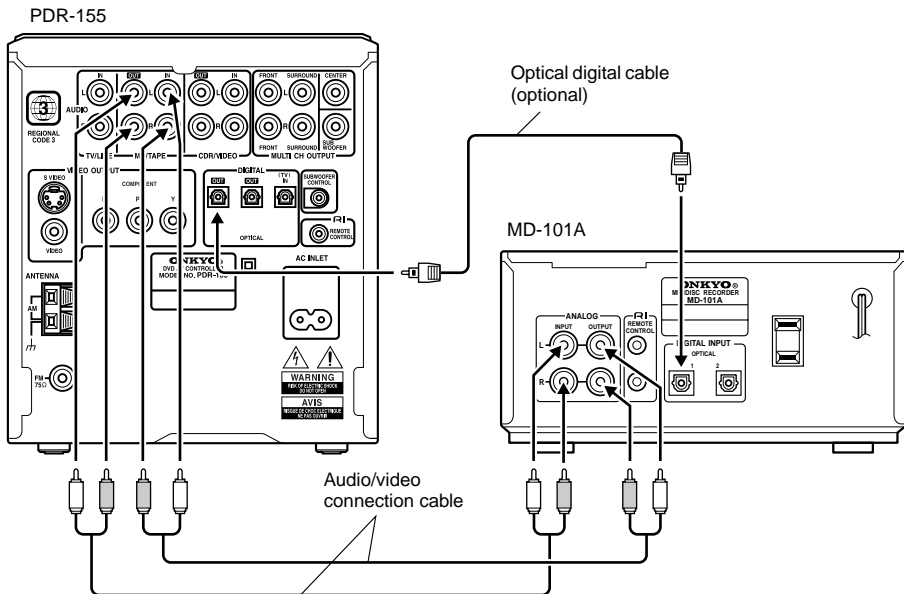

Connecting the PDR-155 to a tape deck (K-501A)

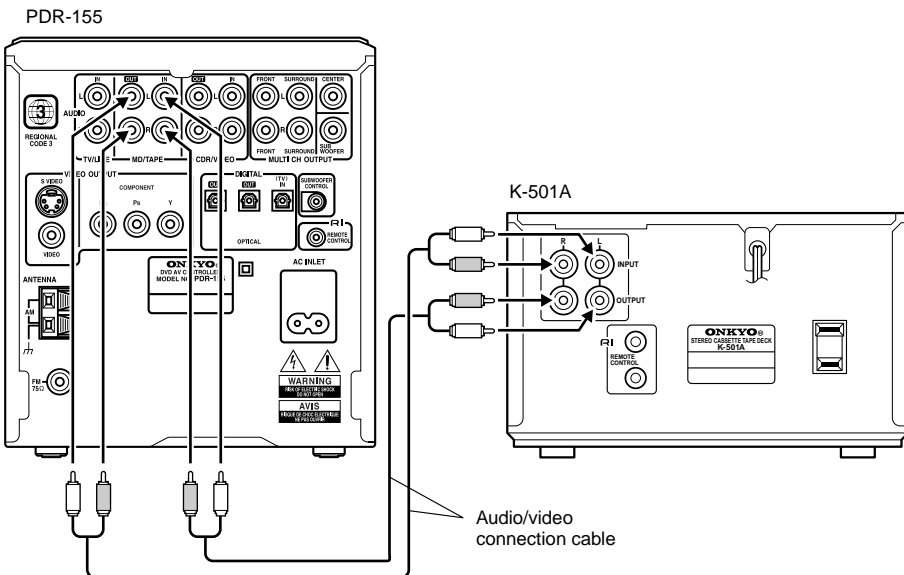

Connections

■ Connecting a CD recorder or VCR (CDR/VIDEO IN/OUT jacks)

You can connect the audio input and output of a CD recorder or VCR to these jacks. Connect the video output from the VCR to the TV.

To connect the L-DR7 to an Onkyo product that has an **RI** jack, select an appropriate input source using the [INPUT] button (page 42).

Connecting an Onkyo Separate Collection Series CD recorder

Connect the PDR-155's CDR/VIDEO AUDIO IN jacks to the CDR-201A's ANALOG OUTPUT jacks.

Connect the PDR-155's CDR/VIDEO AUDIO OUT jacks to the CDR-201A's ANALOG INPUT jacks.

Note that the available components may vary depending on the area.

Connecting other CD recorder or VCR models

Connect the PDR-155's CDR/VIDEO AUDIO IN jacks to the analog audio output jacks of the CD recorder or VCR.

Connect the PDR-155's CDR/VIDEO AUDIO OUT jacks to the analog audio input jacks of the CD recorder or VCR.

- Be sure to insert the cable plugs completely into the jacks. If the connection is incomplete, noise or malfunction may occur.
- Do not bundle the audio pin cables with the power cable and/or speaker cords. Otherwise, tonal quality may deteriorate.
- When you use an optical audio digital cable, do not bend or coil it tightly.
- After all connections are completed, insert the power cable plug into an appropriate AC outlet (page 40).
- The DIGITAL jack has a protective cap installed. When you use this jack, remove the cap. When you are not using this jack, be sure to replace the cap.

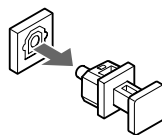
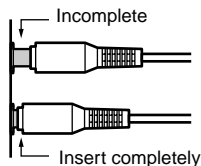

Digital recording from the PDR-155 to a CD recorder

Use an optical digital cable to connect the PDR-155's DIGITAL OUT jack to a digital audio input jack on the CD recorder. If you are using the CDR-201A, use its DIGITAL INPUT 1 jack.

Connections

Connecting the PDR-155 to a CD recorder (CDR-201A)

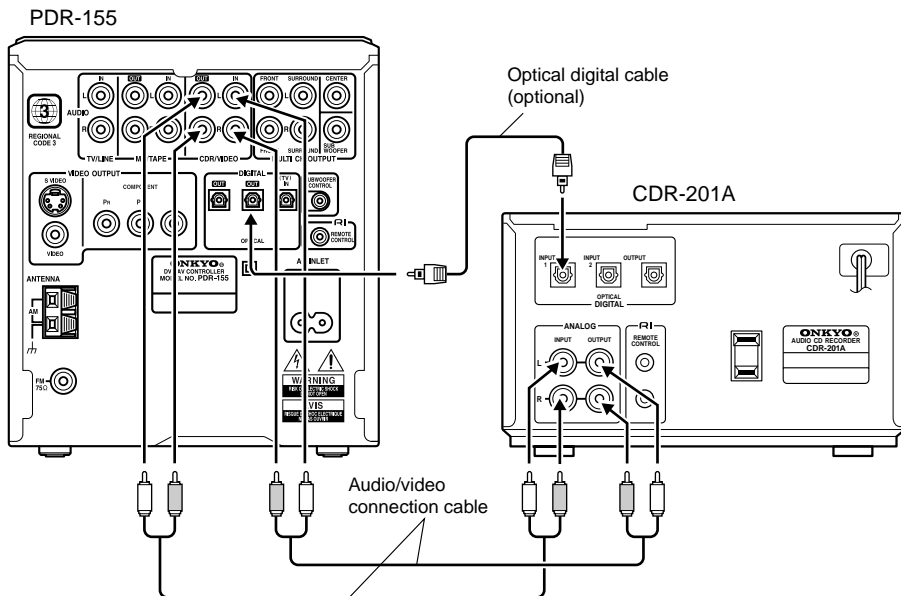

Connecting the PDR-155 to a VCR

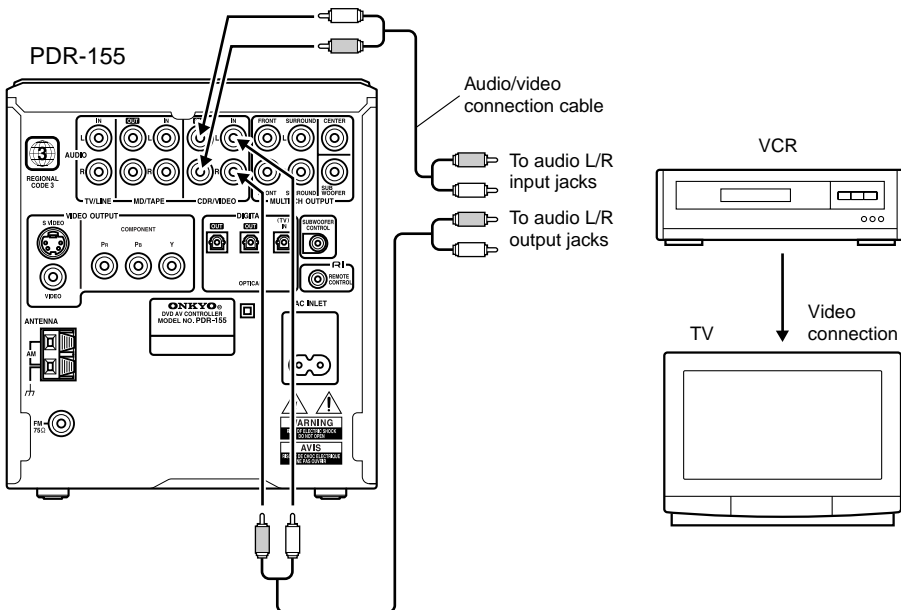

Connections

■ About the **RI** function

If you connect Onkyo Separate Collection Series components to the L-DR7, using the **RI** cables and audio pin cables, you can use the following system functions. An **RI** cable is a special system cable designed for use with Onkyo products. (An **RI** cable is not included in this package.)

The following Separate Collection Series components are commercially available:

- MD-101A MiniDisc (MD) Recorder
- CDR-201A Audio CD Recorder

Note that the available components may vary depending on the area.

Refer to pages 32–35 for more information on connecting the components to the L-DR7.

• **Auto Power On**

- When you turn on the power or start playing one of the components connected to the L-DR7, the PDR-155 turns on automatically. When you turn off the power to the PDR-155, all connected components will be turned off.

• **Direct Change**

When you press the Play button on an MD recorder or CD recorder, the PDR-155 automatically selects the component as the input source.

• **Remote Control Operation**

You can operate all system components using the supplied remote controller. (Refer to page 23 for more information.)

• **Program Timer**

You can program a timer on the PDR-155 so that playback or recording will start automatically on the specified component at the specified time. (Refer to pages 89–95 for more information.)

• **CD Dubbing**

You can perform CD dubbing on an MD recorder or CD recorder from the PDR-155 by pressing just one button. (Refer to the MD-101A or CDR-201A instruction manual for more information.) (The CD Dubbing function cannot be used for DVDs.)

• **CD Dubbing of only selected tracks**

You can program the PDR-155 so that only your favorite songs will be recorded on an MD recorder or CD recorder by pressing just one button. (Refer to the MD-101A or CDR-201A instruction manual and page 97 of this manual.)

- Just connecting an **RI** cable does not enable the system functions. Refer to pages 32–35 and connect the audio pin cables correctly.
- Refer to the instruction manuals for the connected devices for more information on system functions.

Connecting an RI Cable

■ Connecting an RI cable

If you are using an Onkyo product that has an **RI** jack, you can use the system functions. (An **RI** cable is not included in this package. Use an **RI** cable that is shipped with your Onkyo Separate Collection Series component.)

- Use the included remote controller to operate the system functions. Point the remote controller toward the remote sensor of the PDR-155.
- Please refer to the instruction manual for each component when you make connections.

Example

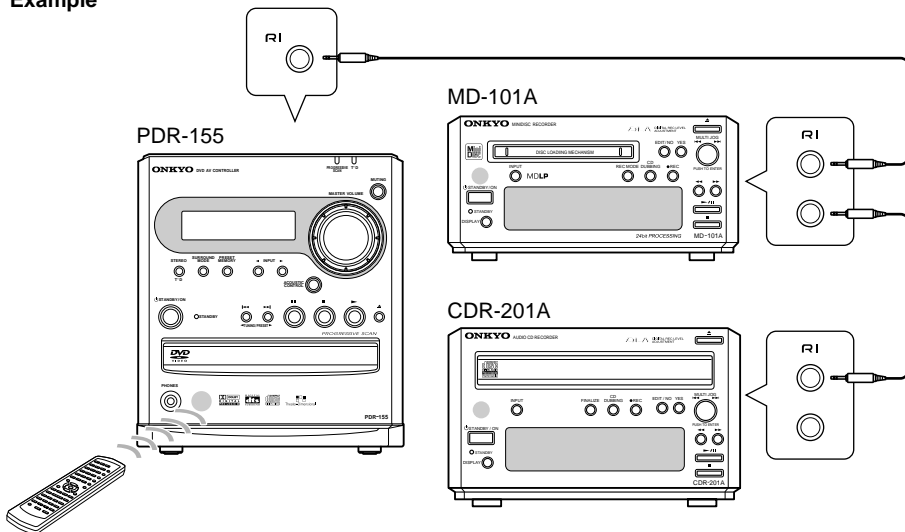

- Use the **RI** jack to connect an Onkyo component that has an **RI** jack.
- If the device has two **RI** jacks, each jack has the same function. You can use either one of them.
- **Just connecting an RI cable does not enable the system functions. Make sure to connect the audio pin cables correctly.**

Making Antenna (Aerial) Connections

Connecting the supplied FM and AM indoor antennas (aerials)

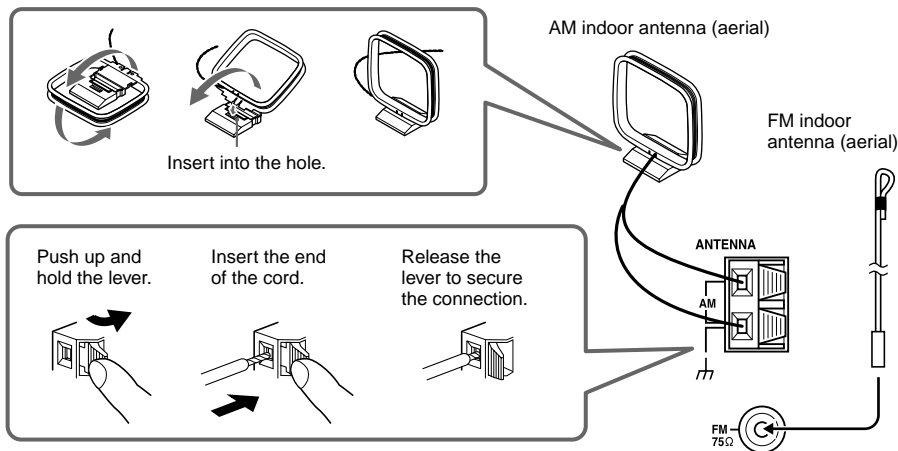

■ Adjusting the position of the FM indoor antenna (aerial)

While listening to an FM program, extend the antenna (aerial) and move it in various directions until the clearest signal is received. Then secure the antenna (aerial) with push pins in the position with the least distortion.

■ Adjusting the position of the AM indoor antenna (aerial)

While listening to an AM program, set the antenna (aerial) in the direction and position where you receive the clearest sound.

Position it as far away as possible from the unit, TVs, speaker cables, and power cords (mains leads).

Note

Insert one end of the AM antenna (aerial) cord into either AM antenna (aerial) connector, and the other end into the other connector. There is no difference between one end of the AM antenna (aerial) cord and the other end — unlike the speaker cords, which have positive and negative poles.

Connecting an AM outdoor antenna (aerial)

An outdoor antenna (aerial) will be more effective if it is stretched horizontally above a window or outside.

Leave the supplied AM indoor antenna (aerial) connected.

Note

To avoid the risk of lightning and electrical shock, grounding is necessary. Follow item 14 of the “Important Safeguards” on page 5 when you install an outdoor antenna (aerial).

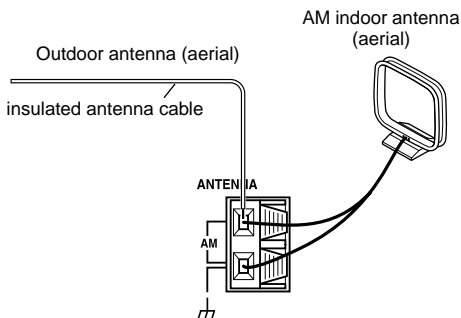

Making Antenna (Aerial) Connections

Connecting an FM outdoor antenna (aerial) (non-European models only)

If the FM reception is not very clear with the supplied antenna (aerial), connect an FM outdoor antenna (aerial) instead of the indoor FM antenna (aerial).

Connecting coaxial cable to a 75/300 ohm antenna (aerial) adapter

- ① Strip the end of the coaxial cable.

15 mm
6 mm 3 mm 6 mm
mm mm mm
1/4 in. 1/8 in. 1/4 in.
3/8 in.
- ② With your fingernail or a small screwdriver, press the stoppers outward and remove the cover.
- ③ Remove the transformer wire A from slit B and insert it into slit C.

Slit B
Wire A
Slit C
- ④ Insert the end of the cable.
- ⑤ Clamp it in place with pliers.
- ⑥ Reinstall the cover.

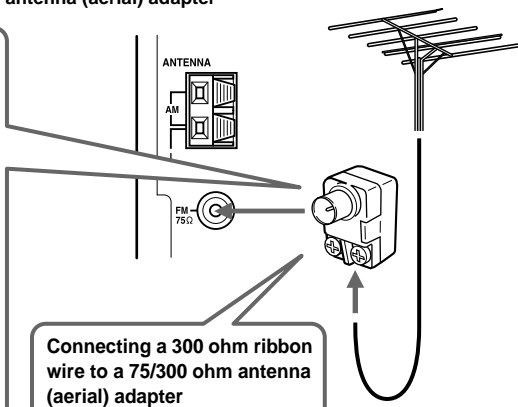

Connecting a 300 ohm ribbon wire to a 75/300 ohm antenna (aerial) adapter

Loosen the screws and wrap the wire around these screws. Then tighten the screws with a screwdriver.

Notes

- Install the antenna (aerial) well away from tall buildings and in an area where FM stations can be directly received.
- Keep the antenna (aerial) away from noise sources (neon signs, busy roads, etc.).
- It is dangerous to put the antenna (aerial) close to power lines. Keep it well away from power lines, transformers, etc.
- To avoid the risk of lightning and electrical shock, grounding is necessary. Follow item 14 of the "Important Safeguards" on page 5 when you install the outdoor antenna (aerial).

Directional linkage

Do not use the same antenna (aerial) for both FM and TV (or VCR) reception, since the FM and TV (or VCR) signals can interfere with each other. If you must use a common FM/TV (or VCR) antenna (aerial), use a directional linkage type splitter.

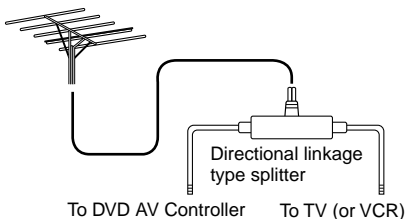

Turning on the PDR-155

Before plugging in the PDR-155

- Make sure that all connections explained on pages 27–39 are complete (the connection to the TV is required).
- Turning on the PDR-155 may cause a momentary power surge, which might interfere with other electrical equipment, such as computers. If this happens, connect the power cable to a wall outlet on a different circuit.

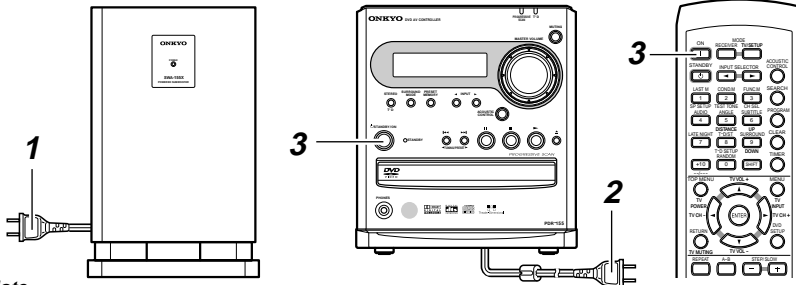

Note

- Depending on the country in which you purchased your controller, the power cord plug may be different to that shown here.

The remote controller buttons used in the following step are illustrated inside a gray rectangle (■).

1

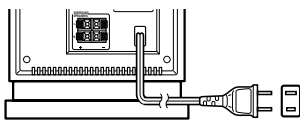

Plug the subwoofer (SWA-155X) into an AC outlet.

Note

- The shape of the power cord plug may vary depending on the area.

2

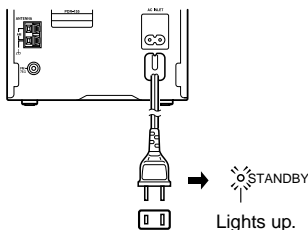

Connect the included power cable to the AC INLET on the PDR-155's rear panel, and plug the cable into a home AC outlet.

- Do not use any power cables other than the included power cable. Also, do not use the included power cable for other equipment.
- To avoid risk of electrical shock, do not connect or disconnect the power cable from the PDR-155's AC INLET while the cable is still plugged into the AC outlet.

3



Press STANDBY/ON on the PDR-155 or press ON on the remote controller to turn on the power to the PDR-155.

The display and indicators on the PDR-155 lights up and the POWER indicator of the subwoofer (SWA-155X) lights up.

Tip

If you press the ON button on the remote controller, the connected **RI** components will also turn on.

Selecting the Number of Speaker Channels

You need to configure the speaker system that you have connected to the SPEAKERS connectors on the rear panel of the SWA-155X (see page 30.)

Notes

- You cannot configure the speaker channels if headphones are connected to the unit (see page 47).
- Once you configure the speaker channels, you will not have to adjust the parameters until you change the speaker configuration.

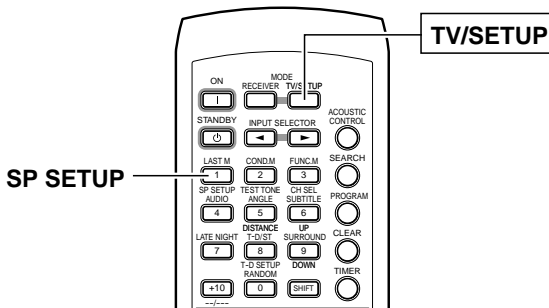

TV/SETUP

→

LAST M

1

SP SETU

5 ch

SP 0 0 0 0 5 ch

(Left/right front, center, and left/right surround speakers)

2 ch

SP 0 0 2 ch

(Left/right front speakers)

3 ch

SP 0 0 0 3 ch

(Left/right front and center speakers)

4 ch

SP 0 0 0 4 ch

(Left/right front, and left/right surround speakers)

Press TV/SETUP, then press SP SETUP repeatedly to select the number of channels for the SPEAKERS system.

Press SP SETUP repeatedly within three seconds to change the number of channels as shown in the diagram on the left. (The corresponding speaker configuration is described in parentheses.)



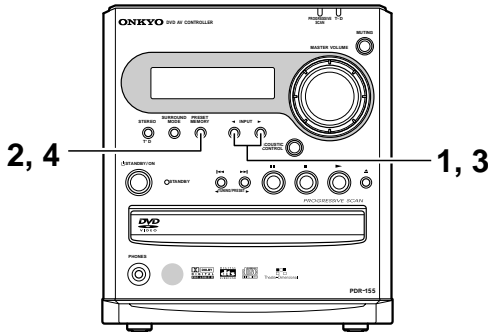

- The unit displays the previous screen in three seconds.
- The default setting is 5 ch.

Changing the Input Source Setting

If you have connected an **RI**-compatible component to the MD/TAPE or CDR/VIDEO jacks, you need to change the input source setting so that the system functions, such as Direct Change, will work correctly.

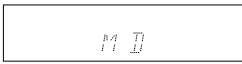

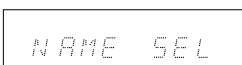
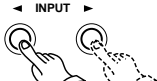
Example: Switching from “MD” to “TAPE”:

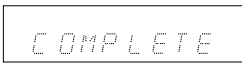
<p>1</p> <p>◀ INPUT ▶</p>  	<p>Press INPUT ◀▶ to display the current input source.</p> <p>The unit displays the current input source (MD).</p>
<p>2</p> <p>PRESET MEMORY</p>  	<p>Press PRESET MEMORY to display the parameter.</p> <p>The unit displays “NAME SEL” for one second.</p>
<p>3</p> <p>◀ INPUT ▶</p>  	<p>Press INPUT ◀▶ to select the connected input source.</p> <p>In this example, select “TAPE.”</p> <p>CDR ↔ VIDEO or MD ↔ TAPE</p>
<p>4</p> <p>PRESET MEMORY</p>  	<p>Press PRESET MEMORY.</p> <p>The unit displays “COMPLETE” and the input source changes accordingly.</p>

Using Setup Navigator

■ Using Setup Navigator to make settings (This function is disabled during playback.)

Setup Navigator was designed to simplify the process of preparing the PDR-155 for use. Designed as a series of on-screen multiple-choice questions, Setup Navigator automatically sets the video and language settings according to your answers to a set of questions. Once this procedure is complete, you can start using the PDR-155 to enjoy DVDs. Setup Navigator prompts you to specify the On-Screen Display language, then the type of TV.

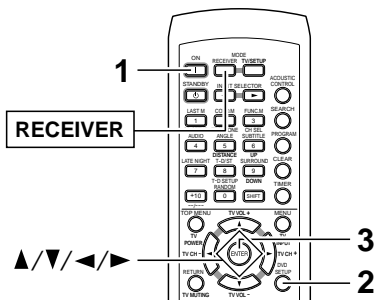

1

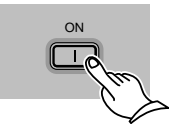

Press the ON button on the remote controller to turn on the power to the unit.

Press ▲ to make sure that no disc is loaded.

2



While “NO DISC” is being displayed, press RECEIVER, then press DVD SETUP to display Setup Navigator on the TV screen.

Start:
Select this option to start Setup Navigator.

Auto Start Off:
Select this option if the Setup Navigator settings have been completed. If you select this, the unit displays the default setting screen (page 99) while the unit is stopped so that you can make detailed settings.

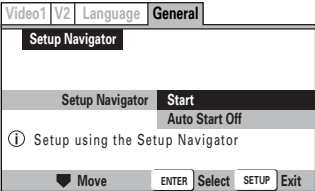

3



Press ENTER to start Setup Navigator.

Setup Navigator displays the OSD language window as shown on the next page.

Tip

The DVD section is not initially activated when you turn on the power to the PDR-155. If the DVD section is not activated, press ▲ to activate it, then use Setup Navigator.

Using Setup Navigator

To display the previous screen while making various settings



Press ◀.

The ⓘ icon in the window stands for “information,” and is followed by a brief explanation of the item selected.

Setting the OSD language (On-Screen Display language)

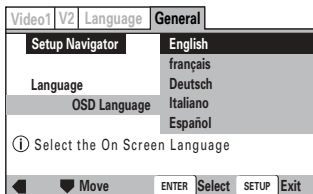
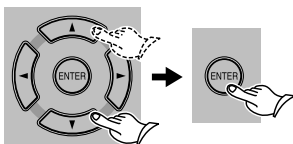

Press ▲/▼ to select the language, then press ENTER.

Options: English (Factory setting)
 Français
 Deutsch
 Italiano
 Español

Asian model options: **English** (Factory setting)
 汉语

Note

The OSD (On Screen Display) screen shots in this manual were taken with the Language set to English (factory setting).

Setting the TV screen size

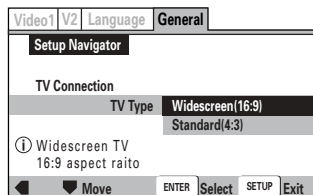
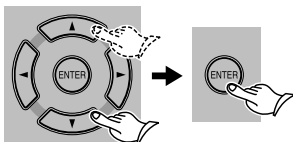

Press ▲/▼ to select the size, then press ENTER.

Options: **Widescreen (16:9)** (Factory setting)
 Standard (4:3)

Using Setup Navigator

Exiting Setup Navigator

Specify whether you wish to exit Setup Navigator after enabling or disabling the edited settings, or to try again to make the setting.

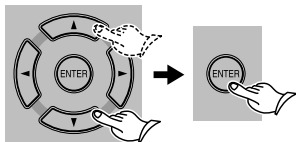

Press ▲/▼ to select an option, then press ENTER.

Tip

To reset all items to the factory default settings, place the PDR-155 in Standby mode (by turning off the power), then press and hold down **■** and press STANDBY/ON on the unit (page 118).

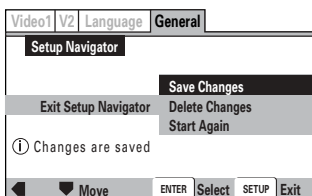

- Options:
- Save Changes (Factory setting)**
Select this option to have the DVD AV Controller make all of the necessary video and language settings according to your responses in Setup Navigator.
 - Delete Changes**
Select this option to exit Setup Navigator without changing any of the system settings.
 - Start Again**
Select this option to return to the OSD Language window in Setup Navigator and make the settings again.

Playing a Connected Source

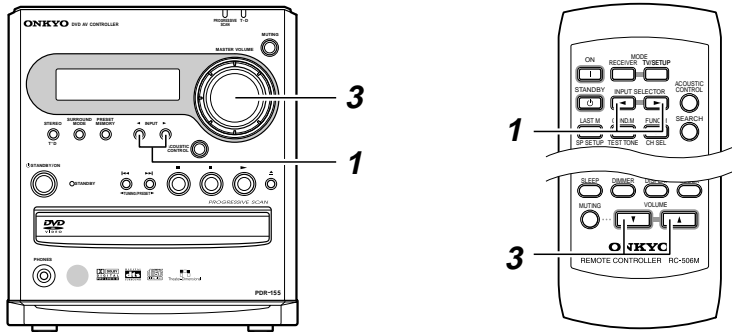

The remote controller buttons used in the following steps are illustrated inside a gray rectangle (■).

<p>1</p> <p>PDR-155</p>	<p>Press INPUT SELECTOR ◀▶ on the remote controller or INPUT ◀▶ on the unit to select one of the connected input sources.</p> <p>Note You cannot select “DVD.” Pressing the ▶ or ▲ button automatically selects the correct input source.</p>
<p>2</p>	<p>Start playing the selected source.</p>
<p>3</p>	<p>Adjust the volume level using MASTER VOLUME on the unit or VOLUME on the remote controller.</p> <p>The volume can set to MIN, 1 through 79, or MAX.</p>

Playing a Connected Source

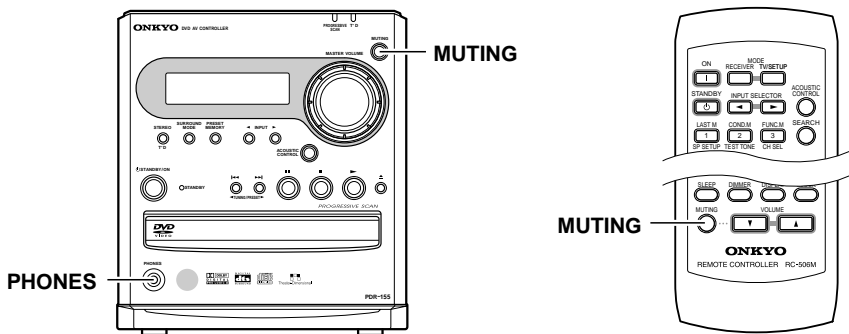

■ Muting the sound

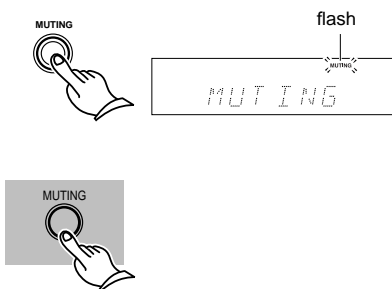

Press MUTING on the unit or remote controller.

The MUTING indicator flashes in the display in mute mode.

To cancel mute mode, press MUTING again. (Muting mode is also cancelled when you press VOLUME or STANDBY on the remote controller.)

■ Listening through headphones

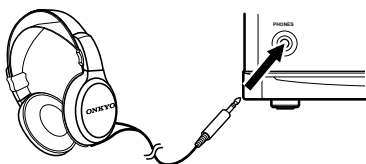

Connect the mini-plug of the stereo headphones to the PHONES jack on the PDR-155.

Be sure to lower the volume level before connecting the headphones.

When you connect the headphones, the surround mode switches to "Stereo," stereo audio is output from the headphones, and the power to the SWA-155X is turned off.

Playing DVDs, Video CDs, CDs and MP3s

■ Please read before starting playback

- Do not play any discs other than DVD videos, video CDs, or audio CDs (see page 11).
- Before playing a DVD video or video CD, first turn on the power to the TV and select the PDR-155 connection for the TV input.
- Depending on the TV or monitor, the color level of the image may appear lighter or the tint may appear slightly different. In this case, optimize the picture quality.

■ About the , , and marks in the following pages and their relation to disc operations



 means the section explains DVD-Video operations.

 means the section explains Video CD operations.

 means the section explains audio CD operations.

 means the section explains MP3 operations.

Notes

- Do not move the PDR-155 during playback. Doing so may damage the disc. Use  on the PDR-155 to open or close the disc tray. Do not touch the disc tray while it is moving. Doing so may cause the PDR-155 to malfunction.
- Do not press down on the disc tray or put any objects other than playable discs on the disc tray. Doing so may cause the PDR-155 to malfunction.
- Generally, the PDR-155 displays an on-screen menu on TV when playback of a movie is complete. Prolonged display of an on-screen menu may damage your television set, permanently etching that image onto its screen. To avoid this, be sure to press  once the movie is complete.
- The DVD section is not initially activated when you turn on the power to the PDR-155. If the DVD section is not activated, press  to activate it.

Playing DVDs, Video CDs, CDs and MP3s

■ Basic disc playback operations

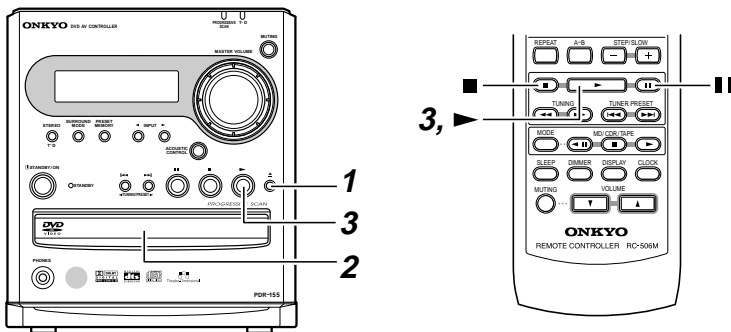

1



Press ▲.

The unit extends the disc tray.

2



Load a disc.

Load a disc with the label side facing up, using the disc tray guide to align the disc.

3

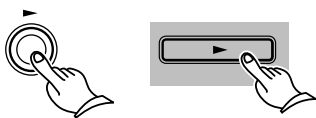

Press ► on the PDR-155 or remote controller.

The disc tray closes, then playback begins. Some discs may automatically start playback when you press ▲ after Step 2 to close the disc tray.

- The unit displays the inserted disc type.

Type of disc

DVD

If an on-screen menu is displayed on TV:  

Refer to “Using the Disc Menu and the Title Menu” (page 53).

Caution:

Do not insert your fingers inside the disc tray. Otherwise, your fingers may be pinched and injured.

Playing DVDs, Video CDs, CDs and MP3s

Pausing playback: DVD VCD CD MP3



Press **|| during playback.**

To resume playback, press **||** again or press **▶**.

When the screen saver appears:

If a disc remains paused for a certain period of time, a screen saver appears. (Alternatively, you can program the unit to disable the screen saver (page 103).) Press **||** or **▶** to display the paused image. Press **||** again or press **▶** to resume playback.

This also applies to CD playback. If CD playback is paused for a certain period of time, the screen saver appears on screen. Press **||** or **▶** to resume playback.

Stopping playback: DVD VCD CD MP3

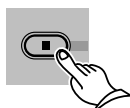

Press **■ once.**

For DVDs or video CDs, the unit displays "RESUME," and the stop position is memorized (Resume function). This function is unavailable with MP3s and CDs.

Resuming playback from the stop position

Press **▶**.

Cancelling the Resume function

Stop playback and press **■** again. Alternatively, eject the disc.

Tips

- If you want to remove the disc but still want to resume playback from the last stopped position, use the LAST MEMORY feature instead (page 65).
- The memorized resume position is erased when you open the disc tray, or change the Parental Lock Level setting (page 112) or On-Screen Display (OSD) language setting (page 108).

Ejecting a disc: DVD VCD CD MP3



Press **▲ on the PDR-155 to open the disc tray.**

When the tray is completely open, remove the disc.

Press **▲** again to close the tray.

Optimizing the image quality DVD

During DVD video playback, visual noise ("snow") may occasionally appear on screen. This suggests that the DVD video may include a large amount of high-resolution data. The degree of visual noise may depend on the TV. If you see some visual noise, adjust the sharpness on the TV to a negative value.

Playing DVDs, Video CDs, CDs and MP3s

Skipping to a chapter or track



You can locate the top of the desired chapter or track quickly.

Skipping forward

During playback, press **▶▶**. repeatedly until you locate the desired chapter or track.

Skipping back to the previous chapter (track)

During playback, press **◀◀**. repeatedly until you locate the desired chapter or track.

Forward and Reverse Scanning

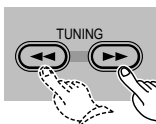

Fast forward

Press and hold **▶▶** on the remote controller (or **▶▶** on the unit) during playback to scan forward.

"▶▶1" blinks on the TV screen during fast forward.

Reverse scanning

Press and hold **◀◀** on the remote controller (or **◀◀** on the unit) during playback to scan backward.

"◀◀1" blinks on the TV screen during reverse scanning.

Resuming normal playback

Release the button at the desired start point.

Changing the fast forward speed

DVDs have three scanning speeds: 1 → 2 → 3

Audio CDs and Video CDs have two scanning speeds: 1 → 2

MP3 have only one scanning speed.

Press ▶▶ during playback to start scanning.

The speed changes as follows each time you press the button:

(slow) ▶▶ 1 → ▶▶ 2 → ▶▶ 3 (fast)

Changing the reverse scanning speed

DVDs have three scanning speeds: 1 → 2 → 3

Audio CDs and Video CDs have two scanning speeds: 1 → 2

Press ◀◀ during playback to start scanning:

The speed changes as follows each time you press the button:

(slow) ◀◀ 1 → ◀◀ 2 → ◀◀ 3 (fast)

Resuming normal playback

Press ▶.

Frame-by-frame playback

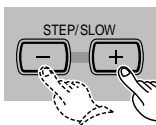

During playback or in pause mode, press **STEP/SLOW +** on the remote controller.

The picture advances one frame each time you press the button.

Reverse frame playback

In pause mode, press **STEP/SLOW -** on the remote controller.

The picture retards one frame each time you press the button.

You cannot use reverse frame playback with video CDs.

Resuming normal playback

Press ▶.

Playing DVDs, Video CDs, CDs and MP3s

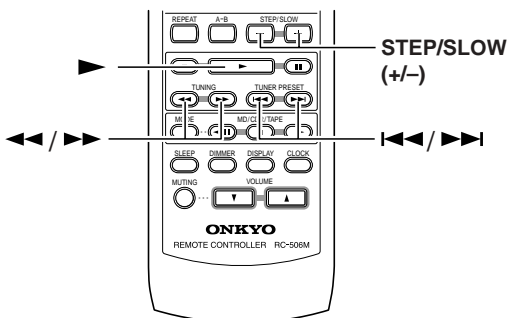

Viewing slow playback

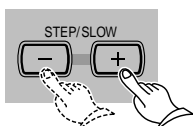

Press and hold STEP/SLOW + on the remote controller.

The unit displays "1/16." Slow playback continues even after you release the button.

Changing the slow motion speed

During slow playback, press STEP/SLOW +.

The speed changes as follows each time you press the button.

1/16 → 1/8 → 1/4 → 1/2 → 1/16

Slow reverse playback

Press and hold STEP/SLOW -.

You cannot use slow reverse playback with video CDs.

Changing the slow reverse playback



During slow playback, press STEP/SLOW -.

The speed toggles between Slow 1 and Slow 2 each time you press the button.

Resuming normal playback

Press ►.

Tips

- While a DVD is stopped, pressing ◀◀ or ▶▶ resumes playback from the top of the title.
- No audio is output during still image, frame-by-frame, or slow playback.
- If a still image is blurred, set "Still Picture" in the default setting window to "Field" (page 107).
- Images may be shaky on some discs during reverse frame playback.
- Still image, frame-by-frame, or slow playback may not be available on some discs. In this case, the unit displays the  or  mark on screen.



Using the Disc Menu and Title Menu



About the disc menu *

DVD videos sometimes contains multiple languages and different audio formats. In these cases, you can generally use the disc menu to select the desired language (for disc menu, voice-over, and subtitle) and the desired audio format. To display the disc menu, press RECEIVER, then press MENU. If the menu does not appear, press TOP MENU. Some discs may not include a disc menu.

About the title menu *

DVD videos and video CDs with the PBC (Playback Control) function (see “About video CDs” on page 12) enable you to select a title or chapter (see “Differences in disc composition” on page 13) from title menu. **To display the title menu, press RECEIVER, then press TOP MENU.** If the menu does not appear, press MENU. Some discs do not include a title menu.

To start playback without displaying the menu screen (without engaging the PBC function), while the unit is stopped, press   repeatedly to select the desired track. Alternatively, press RECEIVER, then press the number buttons.

If the unit has displayed a menu on TV during DVD video playback, press RECEIVER, then use   to select and set the desired items, then press ENTER to confirm the setting. If the unit has displayed a menu on TV during video CD playback, press RECEIVER, then press the number buttons to select and set the desired item.

The operation may vary depending on the disc. Follow the instructions on the disc.

* Some discs may have different names for the disc menu or the title menu. On some discs, the main menu sometimes includes the disc menu and/or the title menu.

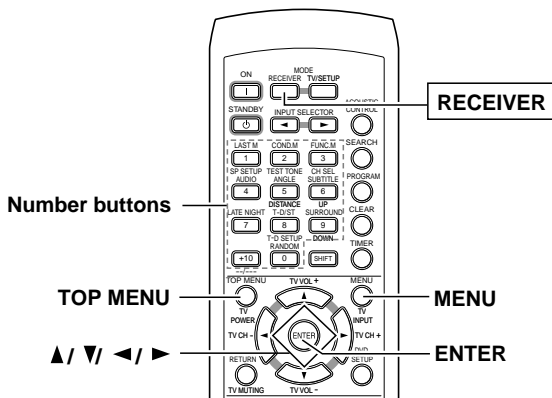

Locating a Point

■ Using the Search function to locate a point DVD VCD CD MP3

SEARCH enables you to search for titles or chapters on a DVD; tracks on a video CD or audio CD; or folders or tracks on an MP3 discs. You can also locate a point by specifying its time value (Time Search).

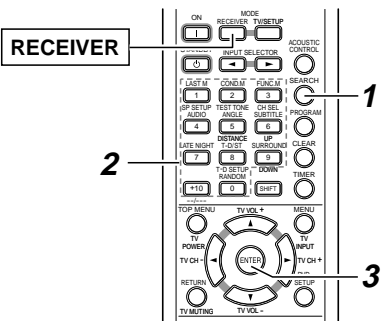

1



Press SEARCH to select the type of search.

The type of search changes each time you press the button, as follows:

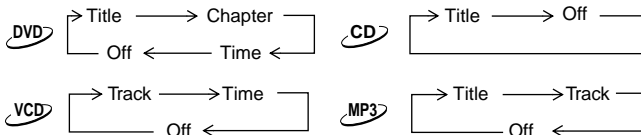

2



Press RECEIVER, then press the number buttons to specify the desired title, chapter, folder, track, or the desired start point (time value).

Searching by title/folder or chapter/track number

Example:

- To select number 3, press 3.
- To select number 10, press 1 then 0.
- To select number 37, press 3 then 7.

Searching by time (Time Search)

Example:

- To locate a point at 21 minutes and 43 seconds, press 2, 1, 4, then 3.
- To locate a point at 1 hour and 14 minutes (74 minutes, 00 seconds), press 7, 4, 0, then 0.

3



Press ENTER.

Notes

- With some discs, you can locate a point using the disc's top menu. In this case, press TOP MENU to display the menu screen and make your selection (page 53).
- The Search functions may be disabled on some DVDs. In this case, the mark is displayed.
- On DVDs or video CDs, playback may start from a point slightly offset from the time you specify.
- Time Search is disabled while the disc is stopped.
- Time Search is disabled during a video CD's PBC playback. Cancel PBC playback (page 53) to use Time Search.
- Time search is disabled on audio CDs and MP3s.

Locating a Point

Locating the desired track using MP3 Navigator

1

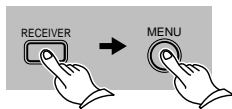

Press **RECEIVER**, then **MENU**.

The unit displays MP3 Navigator.

Number of the currently-playing folder/track

Total number of folders

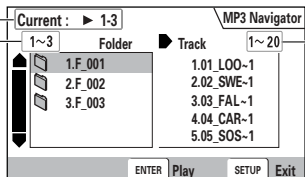

Total number of tracks inside the selected folder

2

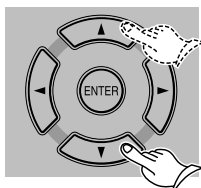

Press **▲/▼** to select the desired folder.

Press **▲/▼** repeatedly to select the previous or subsequent folders.

Selecting and playing a track

① Press **▶**.

The first track in the Track column is selected.

② Press **▲/▼** to select the desired track.

Press **▲/▼** repeatedly to select the previous or subsequent tracks.

③ If you wish to use the selected track(s) for Program playback, press **PROGRAM**.

The selected track will repeat once for each time you press the **PROGRAM** button.

The program mark “” appears. For more information on Program playback, refer to “Programming MP3” on page 61. To delete a track from the Program playback list, press **CLEAR**.

3



Press **ENTER**.

The currently-selected folder or track is played. MP3 tracks that are unplayable on this system are automatically skipped and the unit displays “UNPLAYABLE MP3 FORMAT”

Direct Search

You can quickly locate a point by pressing the number buttons.

Direct Search for a DVD title or chapter

Follow either of the steps below: To specify “18,” press +10, then 8. To specify “20,” press +10 twice, then press 0.

- While the unit is stopped, press **RECEIVER**, then press the number buttons to select the desired title.
- During playback, press **RECEIVER**, then press the number buttons to select the desired chapter.

Direct Search for a CD, video CD, or MP3 track

Press **RECEIVER**, then press the number buttons to select the desired track.

Playback Alternatives — Program Playback

You can arrange the playback order of the titles; chapters within a title; or the playback order of tracks on an MP3, audio CD, or video CD. You can program up to 24 steps.

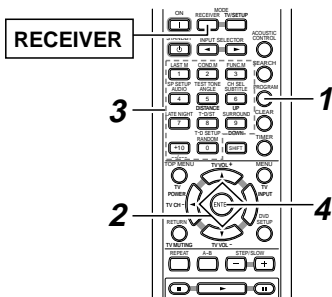

■ Programming a DVD/audio CD/video CD title, chapter, or track



Press PROGRAM.

The Program window appears.

For DVDs, press ◀/▶ to select “Program Chapter” or “Program Title.” For video CDs or audio CDs, skip to Step 3.

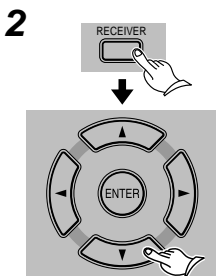

Press RECEPTOR, then press ▼ to move the cursor to the program field box.

When “Program Chapter” is selected, you must also select the title number to which the chapters belong.

1. Use the cursor button (▲) to highlight “Title”.
2. Use the number buttons to enter the title number.

Example: DVD program window

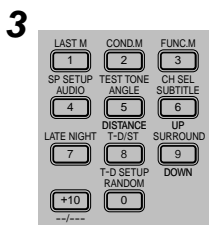
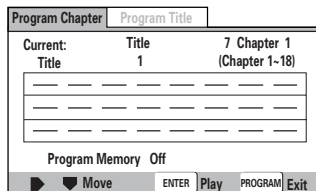

In the program field box, use the number buttons to enter the numbers of the titles or chapters in the desired order.

- To program DVD titles or, for example, chapters 9, 7, and 18 in this order, press 9, 7, +10 then 8. To program title/chapter 30, press +10 three times, then press 0.

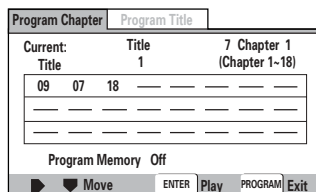

Press ENTER to start Program playback.

To close the window without playing the program, press PROGRAM.

Playback Alternatives — Program Playback

Notes

- Program playback may be disabled on some DVDs. In these cases, the  mark will appear on the screen.
- You cannot use Program playback during PBC playback of video CDs. Cancel the PBC playback (page 53) if you wish to use Program playback
- You can program only the chapters within a title (not in different titles).
- When the chapter changes, the TV screen may sometimes display an image from a chapter that is not programmed. This is not a malfunction.

Programming chapters or tracks while viewing or listening to them

1



While a chapter or track you wish to program is playing, press and hold PROGRAM for one second or more.

Hold down the button until the window shown on the left appears. Repeat this step for the chapters or tracks you wish to program.

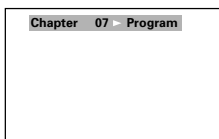



2



Press PROGRAM.

Check the Program window. Press  to start Program playback. To close the window without playing the program, press PROGRAM.

Notes

- If a title has already been input in the Program Title window, the title — not a chapter — will be programmed.
- If some chapters from a title have been input in the Program Chapter window, and if that title is different from the currently-playing title, trying to program the currently-playing chapter will cause the unit to display , and you will be unable to program the chapter.
- If a chapter or track has already been programmed, additional chapters or tracks will be added to the end of the program list.
- If all 24 steps have been programmed, the unit displays , and you will be unable to add any more items.

Checking the contents of the program



Press PROGRAM.

For DVDs, press ◀/▶ to select “Program Chapter” or “Program Title.”

Inserting an item in the program list

Press RECEIVER, then press ▲/▼/◀/▶ to specify the location at which you wish to insert an item in the program field box. Then press the number buttons to specify the desired title, chapter, or track.

Resuming normal playback

Press CLEAR during Program play.

Deleting items from the program list

Deleting programmed items one by one

Press RECEIVER, then press ▲/▼/◀/▶ to specify the item number to delete in the program field box. Then press CLEAR.

The specified number is erased, and the subsequent items shift one position to the left.

Deleting all programmed items

Follow one of the steps below:

- Eject the disc.
- Press CLEAR while the unit is stopped.

Playback Alternatives — Program Playback

■ Programming MP3s

- You can use MP3 Navigator to program tracks (page 55).
- If folder or track names use any characters other than single-byte characters, the names are replaced by numbers, such as “F_001” and “T_001.” No characters other than single-byte characters can be displayed.

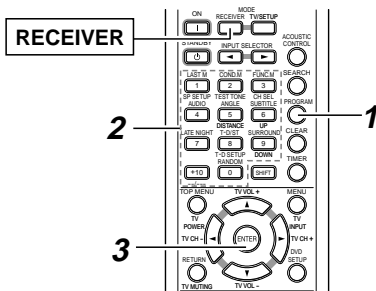

1



Press PROGRAM to display the MP3 Program window.

If you have programmed additional tracks to the program list using MP3 Navigator (page 55), the folder and track numbers are displayed here.

Total number of folders

Folder name Track name

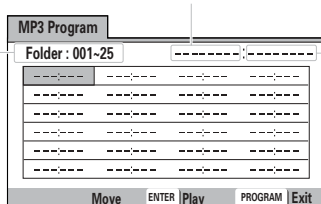

2



Press RECEIVER, then press the number buttons to specify folder and track numbers in the order you wish to play.

(Programming Folder 5 and Track 8 (for example))

Follow the steps below:

1 Press number button “5.”

Folder 5 is programmed.

2 Press number button “8.”

Track 8 is programmed.

Repeat these steps to program other folders and tracks.

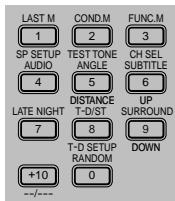

3



Press ENTER.

Playback starts in the specified sequence.

To close the program window without playing the program, press PROGRAM.

Playback Alternatives — Random Playback

You can play titles, chapters, or tracks on a disc in random order.

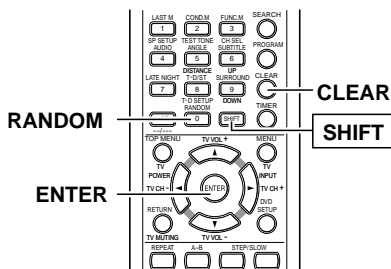

Playing DVD chapters in random order

Playing chapters (scenes) in the current title in random order



Press SHIFT, then press RANDOM within 10 seconds, then press ENTER.

Random playback automatically stops after all chapters are played.

Playing titles in random order

Press SHIFT, then press RANDOM twice within 10 seconds, then press ENTER.

Random playback automatically stops after all titles are played.

Playing CDs, video CDs, or MP3s in random order



During playback, press SHIFT, then press RANDOM within 10 seconds.

Random playback automatically stops after all tracks are played.

Resuming normal playback

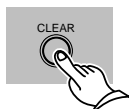

Press CLEAR.

Normal playback resumes with the current chapter or title on the DVD, or the current track on the audio CD, video CD, or MP3.

Notes

- Random playback may be disabled on some DVDs.
- To play songs or scenes in a random order, press **▶▶** during Random playback of a DVD. (Press **▶▶** or RANDOM for a CD, video CD, or MP3.)
- During Random playback, press **◀◀** to play back the current title, track, or chapter from the beginning.
- With video CDs, random play is disabled during PBC playback (while the menu is displayed). To perform random playback, cancel PBC playback, then press RANDOM.
- Random playback is disabled during Program playback of chapters or tracks.
- You cannot repeat Random playback.

Selecting the Camera Angle

■ Viewing from the desired camera angle

DVD

If a DVD contains scenes shot from multiple camera angles, you can switch the angle during playback. Such DVD discs are labelled with a  mark on the jacket.

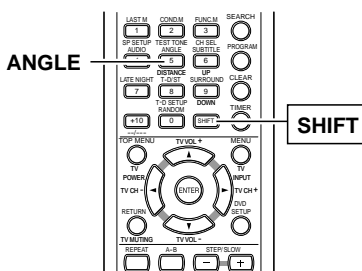

1

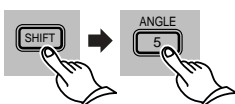

If the  mark appears on the TV screen, **press SHIFT, then press ANGLE** within 10 seconds.

During scenes that were shot from multiple camera angles, the TV screen displays the  mark.

2

Press ANGLE repeatedly within 10 seconds after you **press SHIFT** (as mentioned in Step 1) to select the desired angle.

Each press of ANGLE switches the camera angle.

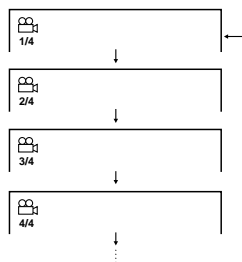

Turning off the mark on the TV screen

If you do not want the  mark to be displayed on the TV screen, set “Angle Indicator” in the default setting window to “Off” (page 107).

Notes

- Some discs may not allow you to change the camera angle even if the  mark appears on screen.
- Pause is cancelled if you change the camera angle during pause.
- You can also select a camera angle using the disc menu on some DVDs.

Selecting the Voice-over/Subtitle Language

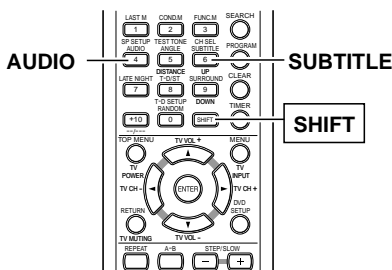

Changing the voice-over language

If a DVD contains multiple voice-over languages, you can select the desired language. On video CDs and MP3s, you can select stereo, 1/L (left), or 2/R (right).

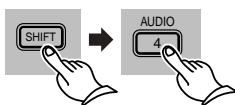

During playback, press SHIFT, then press AUDIO within 10 seconds.

The current voice-over language is displayed. Each time you press AUDIO, the voice-over language changes.

Changing the subtitle language

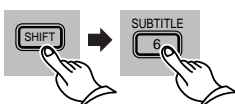

During playback, press SHIFT, then press SUBTITLE within 10 seconds.

The current subtitle language is displayed. Each time you press SUBTITLE, the subtitle language changes.

Turning off the subtitle

Follow one of the steps below:

- Press SUBTITLE, then press CLEAR.
- Press SUBTITLE, then select Off.

Notes

- The voice-over and subtitle languages you select are reset to the default setting as specified in the setup window (page 99) when you perform one of the following operations:
 - Cancelling the Resume function (page 50)
 - Ejecting the disc
- With some discs, switching the voice-over language during playback may cause the screen to freeze momentarily.
- To play only the accompaniment parts on a karaoke CD, follow the steps for selecting audio channels described above to select the desired part(s) as specified on the jacket.
- You can check the language selection only on the TV screen. To switch the MP3 audio selection, check it on the TV screen.
- Some DVD discs may not enable you to change the voice-over/subtitle languages using AUDIO or SUBTITLE on the remote controller during playback. In this case, you need to use the disc menu (page 53).

Playing from the Last Location — Last Memory

The PDR-155 can memorize the location at which you last stopped playback and the settings used at that time for up to five DVD discs. Unlike the Resume function, the location and settings are not erased after you eject the disc. The PDR-155 can memorize the data for one video CD. However, the data is erased once you eject the video CD.

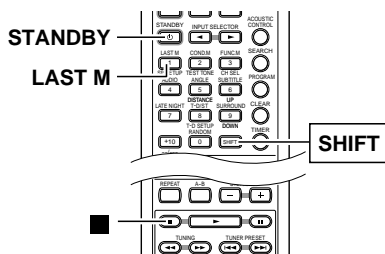

■ Memorizing the Last Memory location

1



During playback, **press SHIFT**, then press **LAST M** within 10 seconds.

The unit displays “Last Memory.” Each time you press the button, the location at which you press the button is memorized.

2

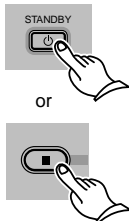

Press **STANDBY** to turn off the power, or press .

Notes

- The Last Memory function may not work for some DVDs.
- You can use Last Memory for up to five discs (after that the one used least recently is deleted to make space for a new one).
- The Last Memory function may not work during PBC playback of a video CD. Cancel PBC playback (page 53) if you wish to use the Last Memory function.

■ Resuming playback from the Last Memory location

1

Load a disc that has had its Last Memory location memorized.

Some DVDs will start playback automatically when loaded. In this case, press  to stop playback.

2



Press SHIFT, then press **LAST M** within 10 seconds.

The disc starts playback from the memorized location. Even with a disc that has its Last Memory location memorized, playback starts from the top of the disc if you press .

Clearing the Last Memory location

1 **Load a disc that has the Last Memory location memorized.**

Some DVDs will start playback automatically when loaded. In this case, press  to stop playback.

2 **Press SHIFT**, then press **LAST M** within 10 seconds.

The disc starts playback from the memorized location.

3 **Press LAST M again.**

The unit displays “Last Memory.”

4 **While “Last Memory” is displayed on the screen, press CLEAR.**

The “LAST” indicator turns off.

Viewing Disc Information

■ Viewing disc information during playback

DVD VCD CD MP3

You can view DVD title/chapter information, video/audio CD track information, or MP3 folder/track information. The PDR-155 displays general information while it is stopped, and displays detailed disc information during playback. The information varies depending on the disc type (DVD, video CD, audio CD, or MP3).

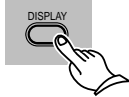
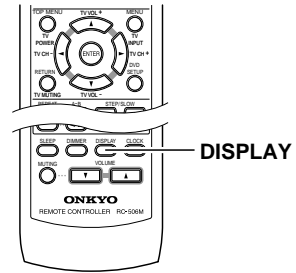

During playback, press DISPLAY repeatedly.

Each time you press the button, the PDR-155 displays the following disc information in the top of the TV screen in the sequence shown below.

Viewing DVD information

Some titles may not display chapter or time information.

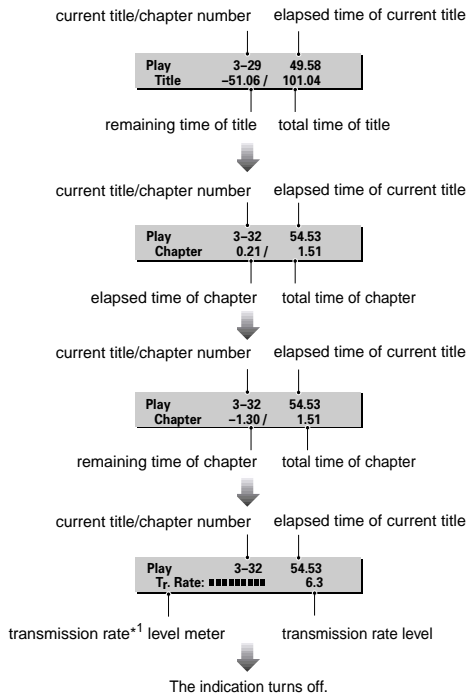

*1 Transmission rate reflects the data size of images recorded on a DVD. A higher transmission rate indicates more image data, but not necessarily better image quality.

Note: Some discs may not display the elapsed time or remaining time.

Viewing Disc Information

Viewing CD information

CD-Rs that are not finalized may not display some disc information.

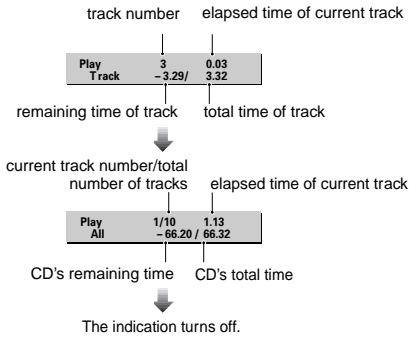

Viewing video CD information

During PBC playback, video CD may not display some disc information.

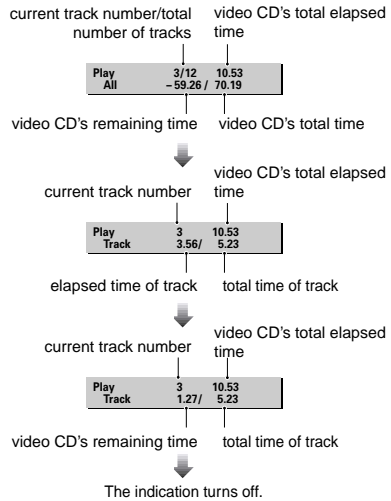

Viewing MP3 information

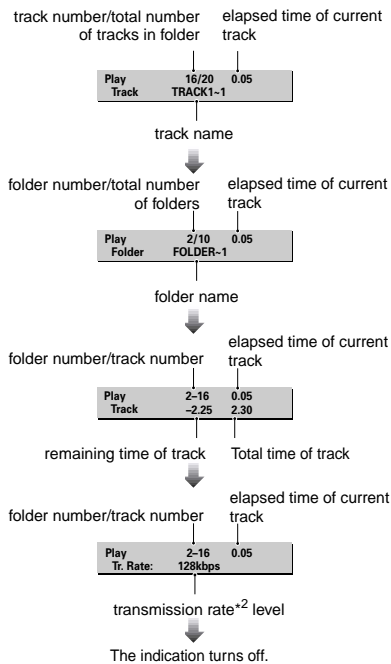

*² Transmission rate indicates MP3 data size.

Viewing Disc Information

■ Viewing disc information while the unit is stopped

DVD VCD CD MP3

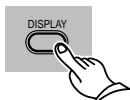
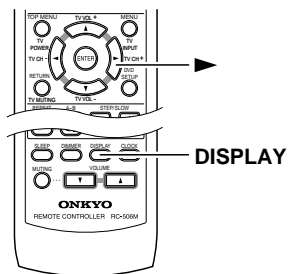

While the unit is stopped, press DISPLAY repeatedly.

The disc's Information window appears. If disc information is on two or more pages, press RECEIVER, then press  to display the next page.

Viewing DVD information

Title numbers and the number of chapters in each title are displayed.

Information: DVD			
Title	Chapter	Title	Chapter
01	1 ~ 30	06	1 ~ 10
02	1 ~ 21	07	1 ~ 13
03	1 ~ 46	08	1 ~ 5
04	1 ~ 12	09	1 ~ 4
05	1 ~ 8	10	1 ~ 8

1/2  DISPLAY Exit

Information is on two pages, and the current window displays the first page.

Viewing MP3 information

Folder numbers and the number of tracks in each folder are displayed.

Information: MP3			
Folder	Track	Folder	Track
001	1 ~ 9	01	1 ~ 10
002	1 ~ 11	02	1 ~ 13
003	1 ~ 3	03	1 ~ 5
004	1 ~ 22	04	1 ~ 4
005	1 ~ 15	05	1 ~ 8

1/2  DISPLAY Exit

Viewing audio/video CD information

Track numbers and time length are displayed.

Information: Compact Disc			
Total time		72 . 04	
Track	Time	Track	Time
01	5 . 23	06	6 . 51
02	4 . 55	07	3 . 18
03	6 . 13	08	6 . 50
04	5 . 45	09	4 . 16
05	5 . 10	10	3 . 22

1/2  DISPLAY Exit

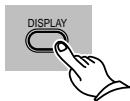

Closing the disc's Information window

Press DISPLAY again.

Boosting the Super Bass/High Ranges

You can enjoy a more dynamic sound by boosting the super bass/high ranges, even at lower volumes.

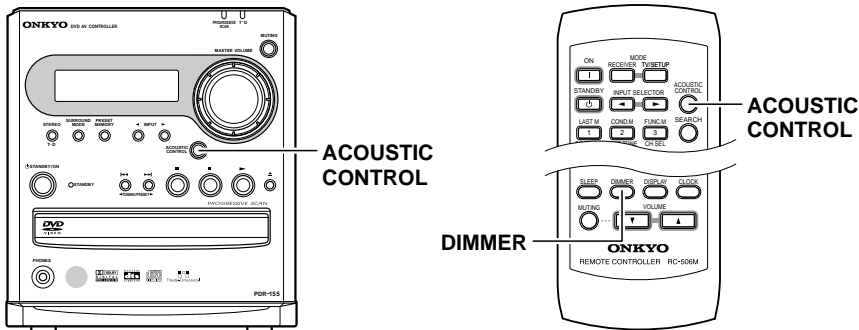

The remote controller buttons used in the following steps are illustrated inside a gray rectangle (■).



PDR-155



Adjust the tonal quality by pressing ACOUSTIC CONTROL on the PDR-155 or remote controller.

Each press of the button changes the acoustic mode as follows:

→ **A. CTRL 1** : The super bass range is boosted.

↓

→ **A. CTRL 2** : The super bass range is boosted. High frequency sounds are also reinforced.

↓

→ **A. CTRL OFF** : Normal sound

Using the DIMMER function

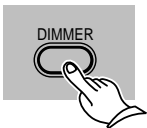

Press DIMMER on the remote controller to change the display brightness.

Each press of the button changes the display brightness as follows:

→ Normal → Dim → Very Dim

Enjoying the Surround Sound

■ About surround sound

The surround sound of the L-DR7 enables you to enjoy the audio ambience of a movie theater or concert hall in your room.

To listen to surround sound, you need to set up the speakers (page 76).

The PDR-155 offers the following surround modes:

STEREO

Sound is output from the left and right front speakers and the subwoofer.



THEATER-DIMENSIONAL

You can enjoy multi-channel playback from two or three speakers.

DOLBY DIGITAL

DTS (Digital Theater System)

This surround mode enables you to experience the acoustics and ambience of theaters or concert halls.

You can enjoy DOLBY DIGITAL sound during the playback of DVDs, LDs, and CDs with the  mark. You can enjoy DTS sound during the playback of discs with the  mark.

DOLBY PRO LOGIC II

This surround mode comprises two categories: Movie mode suitable for movies, and Music mode suitable for music playback.

In Movie mode, the surround channel sound, which is usually monaural and narrow-banded, will be played in stereo, creating the impression of sound movement. Also, in this mode, two-channel music tracks will produce more natural-sounding acoustics through the surround channel.

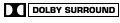
You can enjoy DOLBY PRO LOGIC II sound during playback of VHS and DVD videos that have the  mark, and during some TV programs.

Music mode is suitable for stereo music CDs and live concert DVDs.

Onkyo's original Digital Signal Processing (DSP) modes

The PDR-155 offers the following special Onkyo sound effects for sources other than DOLBY DIGITAL and DTS sounds.

ORCHESTRA

This mode is suitable for classical and opera music. The center channel is cut and the surround channels are emphasized to widen the stereo image. It simulates the natural reverberation of a large hall.

UNPLUGGED

This mode is suitable for acoustic instrumental sounds, vocals, and jazz music. By emphasizing the front stereo image, it simulates the acoustics in front of a stage.

STUDIO-MIX

This mode is suitable for rock and popular music. Lively sounds with powerful acoustics will make you feel as if you are in a club.

TV LOGIC

This mode offers the realistic acoustics of a TV program. It enhances the entire surround sound and clarifies dialog.

ALL CH ST

This mode is useful for background music. The front and surround channels will create a stereo image.

Enjoying the Surround Sound

■ Selecting a surround mode

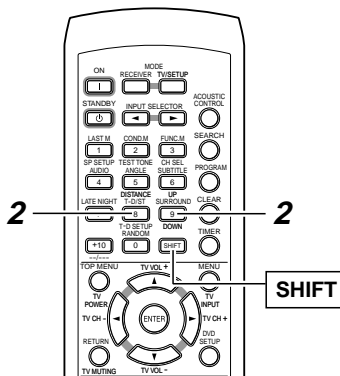
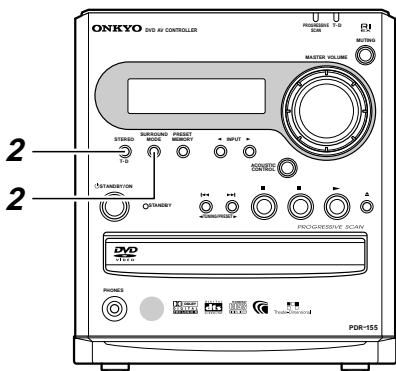

The remote controller buttons used in the following steps are illustrated inside a gray rectangle (■).

1

Play the selected component.

2

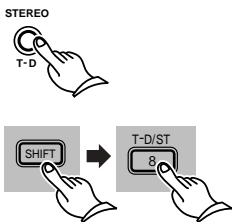

Switching between STEREO and THEATER-DIMENSIONAL

Press T-D/STEREO on the PDR-155 to switch between STEREO and THEATER-DIMENSIONAL.

Alternatively, **press SHIFT on the remote controller, then press T-D/ST within 10 seconds.**

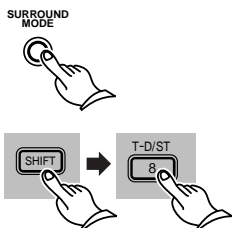

Other surround modes

Press SURROUND MODE on the PDR-155 repeatedly to select the desired surround mode. Alternatively, **press SHIFT on the remote controller, then press SURROUND repeatedly within 10 seconds.**

Each press of the button toggles the mode. The available modes vary depending on the type of input signals. (See the next page.)

Enjoying the Surround Sound

Playback source and available surround modes

Minimum number of speakers	Playback source format	Analog/PCM	Dolby Digital		DTS
			Other than 2/0	2/0	
	Input source Surround mode	Cassette tape deck, Video tape, Audio CD, FM broadcast, AM broadcast	DVD video		DVD video, Audio CD, LD
2 ch	STEREO	●	●	●	●
	THEATER-DIMENSIONAL	●	●	●	●
3 ch	DOLBY D (DOLBY DIGITAL)		●		
	DTS				●
	PL II MOVIE (PRO LOGIC II Movie)	●		●	
	PL II MUSIC (PRO LOGIC II Music)	●		●	
4 ch	ORCHESTRA (DSP)	●			
	UNPLUGGED (DSP)	●			
	STUDIO-MIX (DSP)	●			
	TV LOGIC (DSP)	●			
	ALLCH ST (DSP)	●			

- If the source signal is 96 kHz, you can select only STEREO surround mode.
- If the source signal is from a monaural AM broadcast or TV, and if you select PL II MOVIE or PL II MUSIC, the sound may be output mostly from the center speaker.
To obtain surround effects from monaural sound sources, select other surround modes.

Notes regarding DTS

- If you play a DTS CD or LD in analog mode on a component that is connected only to the PDR-155's ANALOG jacks, the DTS signal will be output as noise. This noise may damage the speakers and the PDR-155. Be sure to play DTS CDs on the PDR-155.
- During playback of a DTS disc, pausing or skipping playback may cause temporary noise. This is not a malfunction.

Enjoying the Surround Sound

■ Adjusting the listening angle

Theater-Dimensional mode is based on a technology that controls the characteristics of the sounds reaching the listener's ears. There is a sweet spot from which you can best experience the Theater-Dimensional effect. Adjust the listening angle for the best Theater-Dimensional effect.

The "listening angle" refers to the angle between the left and right front speakers when directed at the listening position.

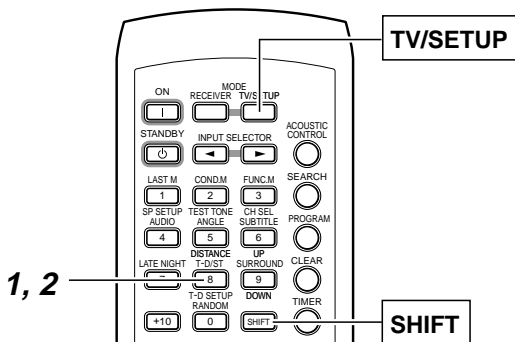

You can use only the remote controller in this procedure.

1

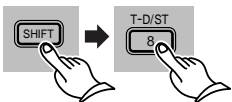

Press SHIFT on the remote controller, then press T-D/ST to select Theater-Dimensional surround mode.

2



Press TV/SETUP on the remote controller, then press T-D SETUP repeatedly.

Each time you press T-D SETUP, the angle changes in the following sequence.

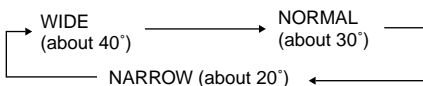

Left front speaker Right front speaker

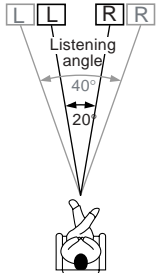

The longer the distance between the two speakers, the wider the angle.

If you are in room that reflects a great deal of sound, you may not be able to obtain the desired effect. We recommend you set up in a less reflective room.

Enjoying the Surround Sound

■ Adjusting each speaker's relative volume temporarily

You can adjust the relative volume of each speaker.

- This adjustment is cancelled when the PDR-155 enters standby mode.
- You cannot adjust the balance in mute mode.

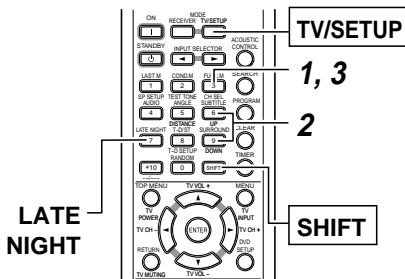

1



During playback, press TV/SETUP on the remote controller, then press CH SEL repeatedly to select the speaker you wish to adjust.

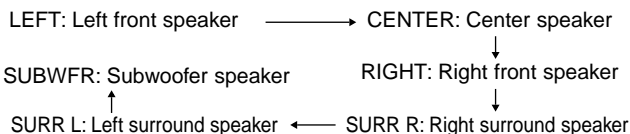

2



Press UP/DOWN on the remote controller to adjust the volume level of the selected speaker.

Pressing UP increases the level, and pressing DOWN decreases the level. You can set the level in the range of -12 to +12.

3

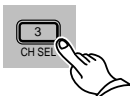

Press CH SEL.

If you press CH SEL while the subwoofer is selected, the unit displays the standard screen. To store the edited value, press TEST TONE.

■ Using the Late Night function (only for Dolby Digital discs)

This function enables you to narrow the dynamic range of Dolby Digital sound. If you lower the volume, for example, to watch a movie late at night, this function will enable you to hear soft sounds more clearly.

This function is cancelled when you place the PDR-155 in Standby mode.

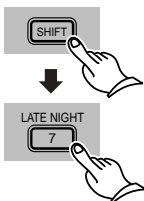

Press SHIFT, then press LATE NIGHT within 10 seconds.

Each press of LATE NIGHT toggles between HIGH and LOW Late Night modes. HIGH mode is more effective than LOW mode.

Notes

- The Late Night function is effective only for Dolby Digital discs.
- The effect of the Late Night function varies depending on the Dolby Digital sound source. Some sources may produce little or no effect.

Setting the Distance to the Speakers

This setting enables you to specify the distance from the listening position to the speakers.

When this distance is correctly specified, the sound from each speaker reaches the listening position simultaneously, improving your home theater experience.

This setting is also memorized in Standby mode.

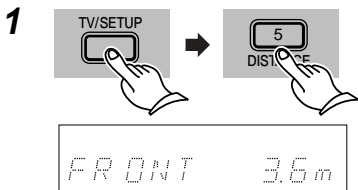
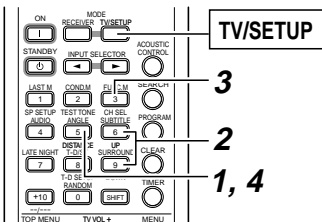

Press TV/SETUP on the remote controller, then press DISTANCE.

The unit displays the distance from the left and right front speakers to the listening position.

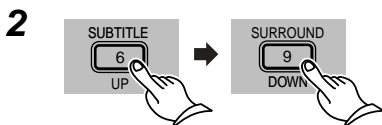

Press UP/DOWN to specify the real distance.

Press UP to increase the value, and press DOWN to decrease the value. You can specify the distance up to 9.0 m by 0.3 m steps.

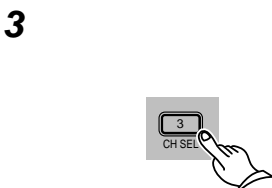

Press CH SEL to select another speaker, then specify the speaker distance.

Each press of CH SEL switches the speaker indication as follows. Follow Step 2 to specify the distance.

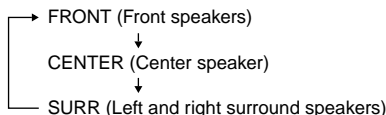

Press DISTANCE.

The specified speaker distances are memorized and the unit displays the standard screen.

Notes

- Set the center speaker distance shorter than that of the left and right front speakers and the left and right surround speakers. The center speaker can be set closer by 1.5 m than the left and right front speakers.
- The left and right surround speakers can be set closer by 4.5 m than the left and right front speakers.
- You cannot set the distance while the headphones are connected.

Balancing the Speaker Volume Levels

Adjust each speaker's relative volume until each speaker's test tone sounds equally loud at the listening position.

- You cannot adjust the level in mute mode or while the headphones are connected.

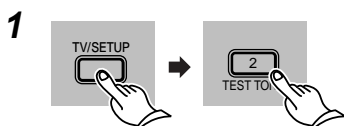
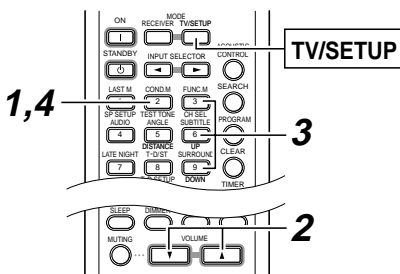

Press TV/SETUP on the remote controller, then press TEST TONE.

Each speaker emits the test tone (pink noise).

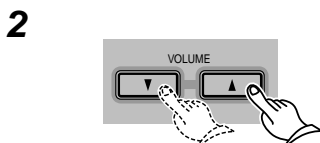
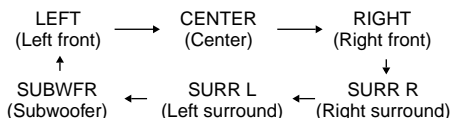

Adjust the volume level.

Press VOLUME ▲/▼ to adjust the level until the test tone is heard clearly.

- If you do not press the buttons while the test tone is sounding, the test tone output will automatically switch to the next speaker. A staccato test tone will be emitted from each speaker in turn.

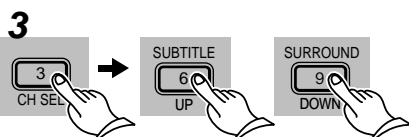

Press CH SEL repeatedly to select a speaker, then press UP/DOWN to adjust the volume level balance.

Press UP to increase the level or press DOWN to lower the level.

- You can adjust the volume level in the range of -12 dB to +12 dB for the satellite speakers.

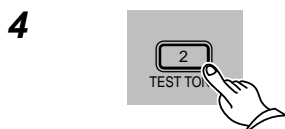
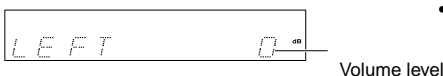

Press TEST TONE.

The level settings are memorized, and the unit displays the standard screen.

Note

- Since the original level of the test tone is soft, if you have raised the volume in Step 2, press VOLUME ▼ after Step 3 to lower the volume to the original level.

Setting the Day and Time

■ Setting the clock

This manual uses the 24-hour clock display in its explanation of how to set the clock. You can also switch the clock to a 12-hour display.

Caution

- In the event of a power outage, or if the power cable is disconnected from the AC outlet, the clock indication turns off. In this case, please set the clock again.
- When using the clock functions, make sure that the power cable is connected to a proper AC outlet that supplies power all the time.

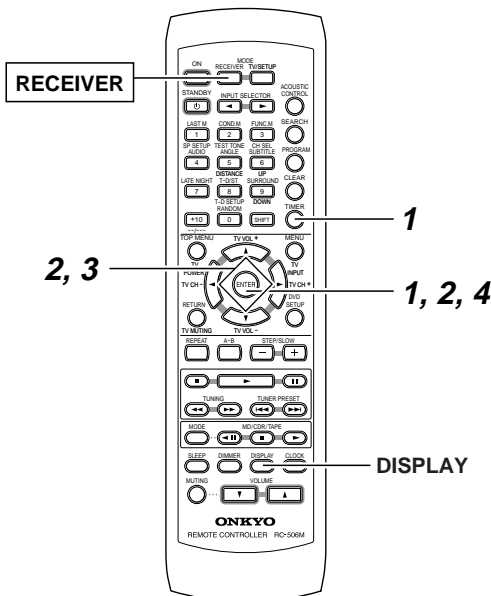

Only the remote controller buttons are used for this procedure.

The unit should be turned on during this procedure. If you do not press any button for eight seconds during the procedure, the unit displays the standard screen.

1

Press TIMER on the remote controller repeatedly to display "CLOCK."

When "CLOCK" appears, press ENTER.

Setting the Day and Time

2

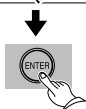
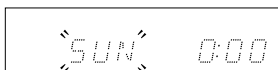
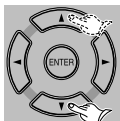

Press RECEIVER, then press ▲/▼ to select a day of the week.

While the desired day of the week is flashing, press ENTER.

Days of the week are displayed as follows:

SUN (Sunday)	THU (Thursday)
MON (Monday)	FRI (Friday)
TUE (Tuesday)	SAT (Saturday)
WED (Wednesday)	

Tip

- To switch between the 24-hour and 12-hour display, press DISPLAY.

3

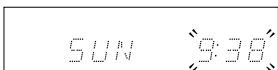
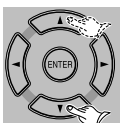

Press ▲/▼ to set the time.

You can also use the number buttons to set the time. To set "9:38," then press number, 0, 9, 3, then 8.

- Press +10 to switch AM and PM on the 12-hour display.

4

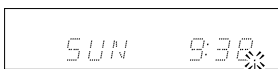

Flashing

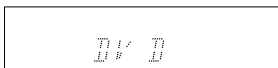

Start the clock.

Match the date, time etc., then press ENTER. The unit displays the input source.

■ Cancelling the operation

Press TIMER.

Displaying the Clock

- Press CLOCK on the remote controller.
If the clock is not set, "ADJUST" flashes. Please set the clock (see page 78).

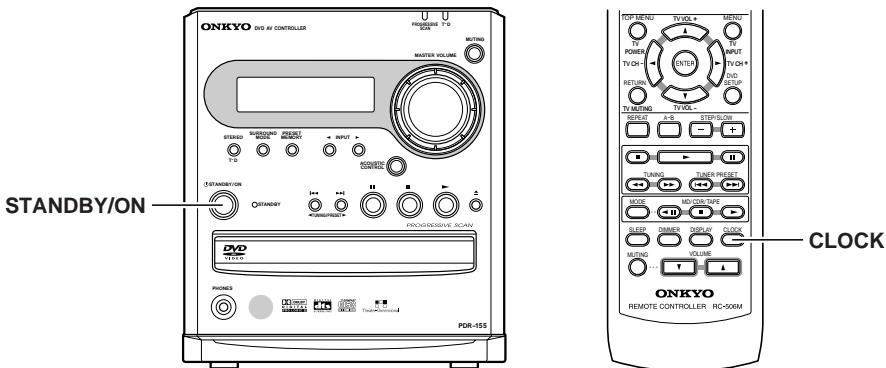

Displaying the current time

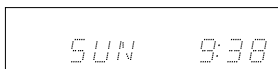
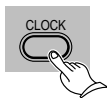

When the unit is turned on, **press CLOCK on the remote controller** to display the current day and time. Press CLOCK again to return to the previous screen.

When the unit is in Standby mode, press CLOCK on the remote controller to display the current day and time. The clock disappears after eight seconds. (Power saving mode)

Displaying or turning off the clock in Standby mode

STANDBY/ON



While the power to the PDR-155 is on, press and hold down STANDBY/ON on the front panel for two seconds or more.

The unit enters Standby mode, and the clock indication is turned on or off.

Note

- Displaying the clock in Standby mode will consume more power.

Listening to the Radio

To listen to the radio, you can either tune the station manually, or program preset stations and select one of them.

■ Tuning Manually

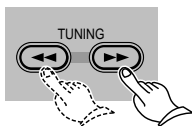

Remote controller

- Each time you press TUNING on the remote controller, FM tuning frequency changes by 0.05 MHz, and AM tuning frequency changes by 9 kHz.
- With FM, press and hold down TUNING on the remote controller for a moment, then release the button. The frequency automatically increases (or decreases) and the next available station is tuned in. (The stations are not programmed at this time.)

■ Programming broadcast stations

To program radio broadcast stations, follow one of the methods below:

- Auto Preset Memory: The PDR-155 receives available FM stations consecutively and automatically stores them.
- Preset Memory: The PDR-155 receives your favorite stations and stores them to the desired preset numbers. You can preset up to 30 AM and FM stations in total.

Note

If the PDR-155 has been unplugged or a power outage continues for more than two weeks, the preset stations and names may be erased. In this case, you will need to program them again.

■ Auto Preset Memory — Automatically storing the stations (only for FM)

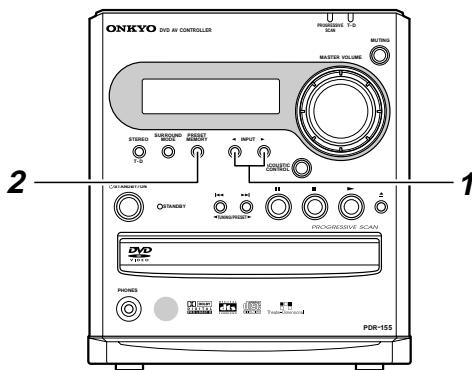

1

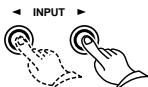

Press **INPUT** ► or ◀ repeatedly to select **FM**.

The unit displays "FM" and a frequency.

Listening to the Radio

2

PRESET
MEMORY



Press and hold down PRESET MEMORY (for about 6 seconds) until “Auto Mem” flashes and the receiver starts searching for the next available station.

▶●◀ flashes. The unit displays the frequency value and starts searching for the next available station.

- Up to 20 stations are automatically programmed to preset numbers, in order, starting with the lowest frequency.

Note

- All FM stations previously stored in memory will be replaced with the new Auto Memory stations.

■ Using RDS (European models only)

When tuned into an RDS (Radio Data System) station that’s broadcasting PS (Program Service Name) information, the RDS indicator lights up and the name of the station appears on the display.

Only European models support RDS, and only in areas where RDS is used.

■ Switching between Auto and Mono mode

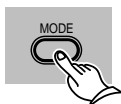

FM STEREO indicator lights up

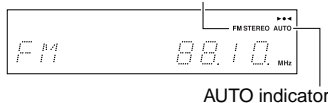

To receive FM stereo broadcast stations, press MODE on the remote controller to turn on the “AUTO” indicator.

- When the unit receives an FM stereo broadcast in Auto mode, the FM STEREO indicator lights up.

Tips

- At a frequency with weak radio signals or with a lot of noise, the FM STEREO indicator does not light up. If the FM STEREO indicator is flashing, press MODE again to turn off the AUTO indicator and switch to monaural reception. In this way, you can reduce noise and intermission.
- If the reception is poor, adjust the direction of the indoor antenna or move the antenna near a window or find a location with strong signals. If the situation does not improve, install an outdoor antenna.

Listening to the Radio

■ Preset Memory – Receiving and programming your favorite stations

You can preset up to 30 AM and FM stations. If you try to program more stations, the unit displays “MEM FULL” and you will be unable to program them.

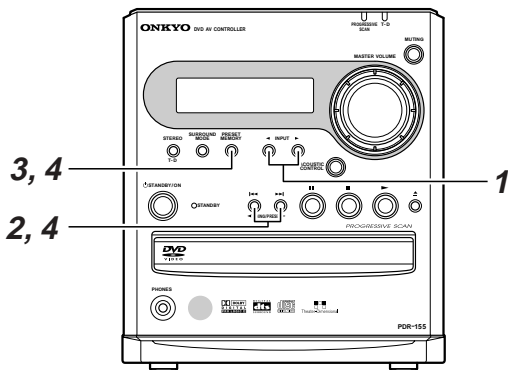

1

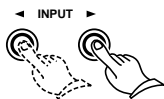

Press **INPUT** ► or ◀ repeatedly to select FM or AM.

2

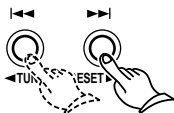

Press **TUNING/PRESET** ► or ◀ to select the desired broadcast station (frequency).

Tips

- When the unit receives the station, the ►●◀ (tuned) indicator lights up.

Listening to the Radio

3

PRESET
MEMORY

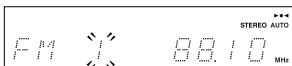

Press PRESET MEMORY.

The preset number flashes.

Note

- If you do not proceed to the next step within eight seconds after you press PRESET MEMORY, the unit displays the previous frequency screen.

4

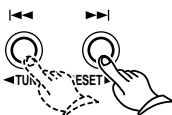

PRESET
MEMORY



Select the desired preset number and program the station to the number.

Press TUNING/PRESET ► or ◀ to display the desired preset number.

While the desired preset number is displayed, press PRESET MEMORY.

Tip

- Repeat Steps 2 – 4 to program the desired stations.

Listening to the Radio

■ Listening to a preset station

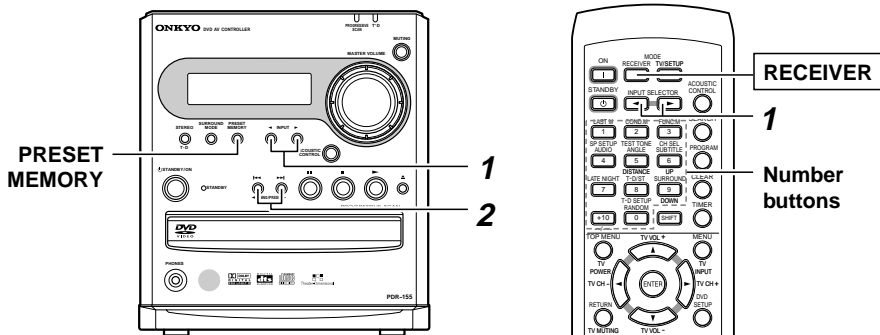

The remote controller buttons used in the following steps are illustrated inside a gray rectangle (■).

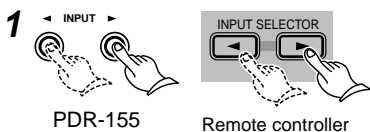

Press **INPUT** ► or ◀ on the PDR-155, or **INPUT SELECTOR** on the remote controller repeatedly to select FM or AM.

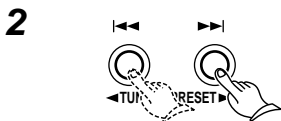

Select the desired preset number.

Press **TUNING/PRESET** ► or ◀ on the PDR-155 repeatedly to display the preset number, or press ◀/▶ or the number buttons on the remote controller to receive the desired station.

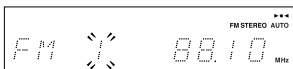

Tip

• To use the number buttons, first **press RECEIVER**, then press the number buttons.

5 : 5

12 : +10 1 2

25 : +10 2 5

• If you operate the remote controller during AM reception, noise may be induced.

■ Erasing a preset station



- 1 Select the preset station you wish to erase (see the steps described above).
- 2 Press **PRESET MEMORY** to display a flashing “ERASE.” While “ERASE” is flashing, press **PRESET MEMORY** again. The selected preset station will be erased.

Entering Characters

■ Naming the preset stations

You can name the preset stations using up to 8 characters.

- You can use the following characters:

_ A B C D E F G H I J K L
 M N O P Q R S T U V W X Y
 Z " ' & () [] * + , - . / = ?
 0 1 2 3 4 5 6 7 8 9

_ represents a space.

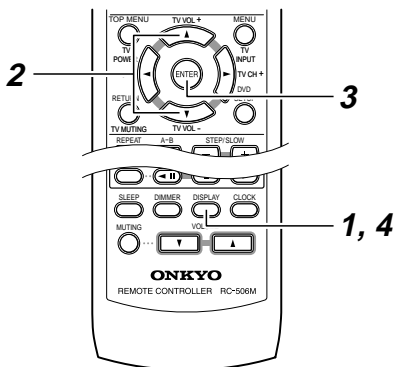

Only the remote controller buttons are used in this procedure.

First select the preset station you wish to name.

1		<p>Press and hold down DISPLAY (for three seconds) to display “NAME IN.”</p>
2		<p>Select a character. Press ▲/▼ to select a character.</p>
3		<p>Press ENTER to enter the character. Repeat Steps 2 and 3 to enter up to eight characters.</p> <p>Tip</p> <ul style="list-style-type: none"> If you wish to leave the name blank, press ENTER while no character is displayed.
4	 <div style="border: 1px solid black; padding: 5px; width: fit-content; margin: 0 auto;">COMPLETE</div>	<p>Press and hold down DISPLAY (for three seconds) to store the name. When you enter eight characters, the naming operation is automatically complete.</p>

Note

- You can't name a preset that's tuned to an RDS station broadcasting PS (Program Service Name) information. (See page 82 for more information on RDS stations.) Only European models support RDS, and only in areas where RDS is used.

Entering Characters

■ Changing the characters

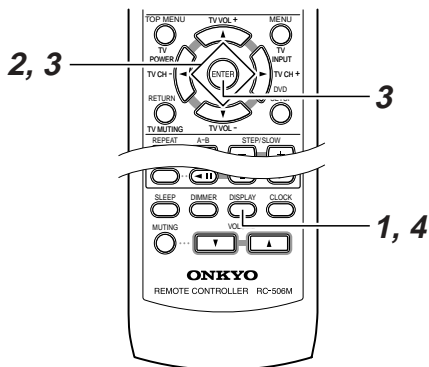

Only the remote controller buttons are used in this procedure.
First select the preset station you wish to edit.

1

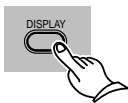

Press and hold down DISPLAY (for three seconds) to display “NAME IN.”

2

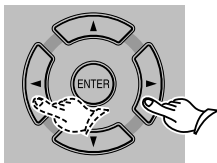

Select a character to edit.

Press ◀/▶ repeatedly until the character you wish to change flashes.

3

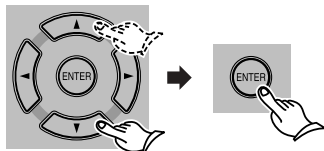

Press ▲/▼ to select a new character.

- After you select a new character, press ENTER.
- Repeat Steps 2 and 3 if you wish to change other characters.

4

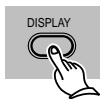

Press and hold down DISPLAY to display COMPLETE and store the change. (This process takes about three seconds.)

COMPLETE

Entering Characters

Deleting the characters

1

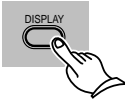

Press and hold down DISPLAY to display "NAME IN."

2

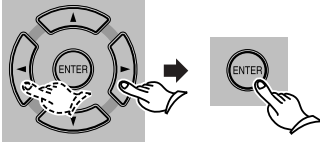

Select a character to delete.

Press ◀/▶ repeatedly until the character you wish to delete flashes.

3

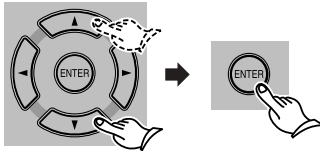

Press ▲/▼ to select [_], then press ENTER.

To delete all characters, repeat Steps 2 and 3.

Changing the preset indication

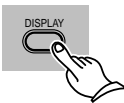

Each press of DISPLAY toggles between two types of preset indications as follows:

Preset number and frequency → Preset name (if named)

Tip

- If a preset station has been named, the name is displayed as default. If it is not named, the preset number and frequency are displayed.

Using the Timer Functions

■ Using Sleep Timer

- At the specified time, the PDR-155 enters Standby mode.
- If Sleep Timer is enabled during timer playback or recording, the unit enters Standby mode at the time specified.

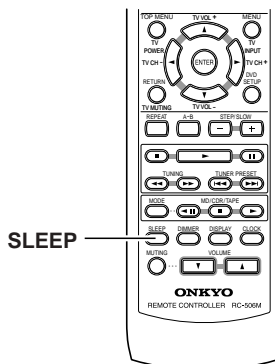

Press SLEEP on the remote controller repeatedly to specify the time required until the unit enters Standby mode.

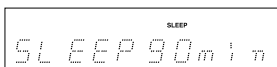

The unit displays "SLEEP 90," which means the unit will enter Standby mode in 90 minutes.

Each press of the button shortens the time duration by 10 minutes.

- The SLEEP indicator lights up while the Sleep Timer is activated.

Checking the remaining time

If you press SLEEP while the Sleep Timer is active, the unit displays the time remaining until the unit enters Standby mode.

If you press SLEEP while the unit displays 10 minutes or less of remaining time, the Sleep Timer will be cancelled.

Canceling Sleep Timer

Press SLEEP repeatedly until the unit displays "SLEEP OFF," or place the unit in Standby mode, then turn the unit on again.

Note

- If the specified time for the Sleep Timer expires during "CD dubbing," the unit enters Standby mode after "CD dubbing" is complete.

Using the Timer Functions

Selecting a Timer

You can program up to four Timers.

Types of Timer

- Play Timer: The selected component starts playback at the specified time.
- Rec Timer: The selected component starts recording at the specified time.
Rec Timer can record on a connected MD recorder or tape deck that is equipped with an **RI** connector. Specify the input source correctly.

Selecting a playback source

As a playback source, you can select either AM, FM, or DVD on the PDR-155, and the connected component that features the timer function.

As a recording source, you can select AM or FM on the PDR-155, or TV.

Setting a day of the week

Timers can function only once (Once Timer) or function on a specified day of the week at a specified time (Every Timer).

You can set Every Timer to function everyday, or on specified consecutive days of the week, such as every Monday through Friday, or every Saturday and Sunday.

Example:

Timer 1: To use this timer to wake up with, set it as follows:

Play Timer → Every Timer → Everyday → 7:00 - 7:30

Timer 2: To use this timer to record radio programs weekly, set it as follows:

Rec Timer → Every Timer → Monday ~Saturday → 15:10 - 15:30

Timer 3: To use this timer to record a radio program this Sunday, set it as follows:

Rec Timer → Once Timer → Sunday → 10:00 - 12:00

Notes

- You cannot change the current clock time or the end time of the timer program during timer playback or recording.
- You cannot program a timer unless you set the current time. Be sure to set the clock first.
- Make sure that you connect a component to the PDR-155 correctly before you program a timer to play or record on the connected component. If the connection is incomplete, timer playback or recording will not be performed.

About timer indication



If a timer has been programmed, the TIMER indicator lights up. If the indicator lights up when you press TIMER repeatedly to display the type of timer, it means that the corresponding timer has been programmed.

If the specified time for two timers overlaps:

- The timer that starts earlier has priority.
- If two timers start at the same time, the timer with the lower timer number has priority.

Timer 1: 9:00 - 10:00

Timer 2: 8:00 - 10:00 ← Priority (This timer starts earlier.)

Timer 3: 12:00 - 13:00 ← Priority (This timer number is lower.)

Timer 4: 12:00 - 12:30

Using the Timer Functions

■ Programming a timer

Before programming a timer for AM or FM broadcast, first preset the desired station (page 81).

Notes

- If the clock has not been set, you cannot program a timer.
- If you do not operate the unit for more than 60 seconds while you are programming a timer, the unit displays the standard screen.

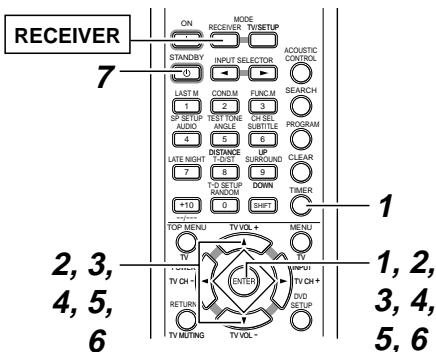

Only the remote controller buttons are operated in this procedure.

1 Selecting a timer number

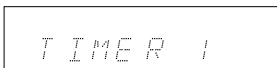

Press **RECEIVER** on the remote controller, then press **TIMER** repeatedly to select the number of the timer you wish to set.

Select from Timer 1 - 4, then press ENTER.

Tip

- The **TIMER** indicator lights up in the upper-left corner if a timer has been programmed.

2 Selecting a type of timer

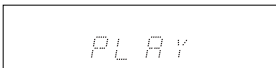

Press **▲/▼** to select **Play** or **Rec Timer**.

When the unit displays the desired timer, press **ENTER**. With **Rec Timer**, recording will start on a connected Onkyo MD or tape recorder.



3 Selecting a component to play



Press **▲/▼** to select a component to start playing with the timer.

When the unit displays the desired component, press **ENTER**.

For **Rec Timer**, you can select **FM**, **AM**, or **TV**.

If you have selected **FM** or **AM**

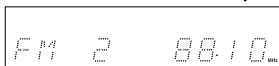

Press **▲/▼** to select a preset station number.

When the unit displays the desired preset station number, press **ENTER**.

Using the Timer Functions

4 Specifying a day of the week



EVERY

Press ▲/▼ to select “ONCE” or “EVERY.”

With “ONCE,” the timer works once. With “EVERY,” the timer works weekly.

After selecting one of the options, press ENTER.

With “ONCE,” the timer works once on the specified day of the week.



SUN

Press ▲/▼ to select a day of the week.

When the unit displays the desired day of the week, press ENTER.

Days of the week are displayed as follows:

MON (Monday)	FRI (Friday)
TUE (Tuesday)	SAT (Saturday)
WED (Wednesday)	SUN (Sunday)
THU (Thursday)	

With “EVERY,” the timer works on the specified day every week.

Press the cursor buttons (▲/▼) to select a day of the week.

When the unit displays the desired day of the week, press ENTER.

SUN	↔	MON	↔	TUE	↔	WED	↔	THU
↑								↓
DAYS SET*	↔	EVERY DAY	↔	SAT	↔	FRI		

* You can specify consecutive days of the week.

If you have selected “DAYS SET,” you can specify consecutive days of the week.

MON-SAT



TUE-

1 Press ▲/▼ to select the first day of the week you wish to program.

When the unit displays the desired day of the week, press ENTER.



TUE-SUN

2 Press ▲/▼ to select the last day of the week you wish to program.

When the unit displays the desired day of the week, press ENTER.

In this example, the timer recording starts at the specified time on every Tuesday through Sunday.

Using the Timer Functions

5 Specifying the On time

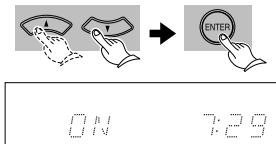

Press ▲/▼ to specify the timer On time.

When the unit displays the desired time, press ENTER.

You can also use the number buttons to specify the time. For example, to program 7:29, **press RECEIVER**, then press 0, 7, 2, and 9.

Press +10 to switch AM and PM on the 12-hour display.

Notes

- When you set the On time, the Off time is automatically set to an hour later.
- If an MD recorder is programmed to start recording by a timer, the first few seconds of the signal may not be recorded. Program the On time to a value that is about one minute earlier than the desired On time.

6 Setting the Off time

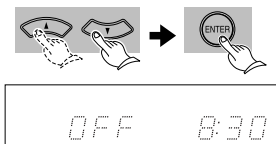

Press ▲/▼ to set the timer Off time.

When the unit displays the desired time, press ENTER.

7 Placing the unit in Standby mode.

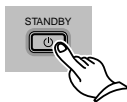

Turn off the power to place the unit in Standby mode.

Press STANDBY to place the unit in Standby mode.

- During timer recording, the unit is muted and the subwoofer (SWA-155X) is not turned on. If you wish to audition the sound during recording, press MUTING to cancel mute mode. The subwoofer is turned on and you will be able to hear the sound.

Notes

- If you wish to record FM or AM analog signals to an MD recorder, be sure to select "Analog In" for the MD's recording input source.
- Unless the unit is in Standby mode, the timer will not work at the programmed time. Be sure to place the unit in Standby mode by pressing STANDBY so that the timer will work.

■ Cancelling the timer programming operation

Press TIMER.

Using the Timer Functions

■ Switching the timer on (activating) or off (deactivating)

- Follow the steps below to cancel the programmed timer, to enable the cancelled timer, or to perform timer recording again.
- The timer will not work unless the clock is set.

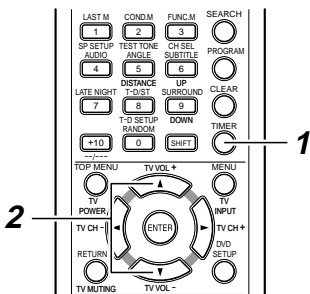

Only the remote controller buttons are used in this procedure.

1



Press TIMER repeatedly to display the desired timer number.

If the TIMER indicator is lit above the timer number, the timer has been On (activated).

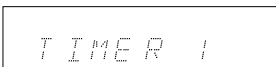

2



Press ▲/▼ to switch between On (activating) and Off (deactivating).

The unit displays the standard screen two seconds after you switch the setting.

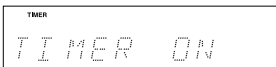

or

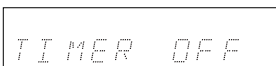

Using the Timer Functions

■ Checking the timer settings

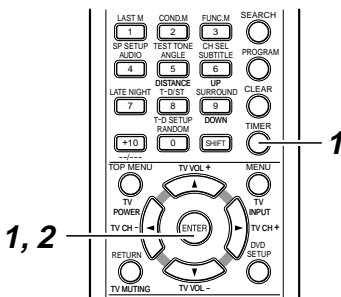

1

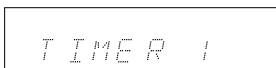

Press TIMER repeatedly to display the desired timer number. Press ENTER.

If the TIMER indicator is lit above the timer number, the timer has been On (activated).

2

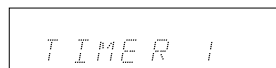
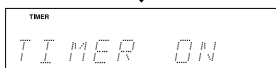
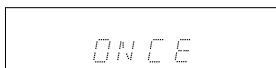

Press ENTER to check the next setting.

Press ENTER repeatedly to check the subsequent settings.

Notes

- You can also edit the settings, using ▲/▼ while you are checking them.
- If the timer has been Off, and if you edit the setting, the timer automatically turns On.

If all settings are correct and you do not need to make any changes, press the TIMER button to display the standard screen.

Recording

The copyright laws prohibit using your recordings without consent of the copyright owner, except for the purpose of your personal entertainment.

Although the PDR-155 is a play-only device, you can perform CD dubbing with one button press by connecting an Onkyo Separate Collection Series component, such as the CDR-201A or MD-101A. (Note that the available components may vary depending on the area.)

Notes regarding recording

- You cannot copy DVD video to a CD recorder or MD recorder.
- You cannot digitally record DVD disc audio that contains a copy-protection signal.
You can record only PCM audio signals that are not copy-protected, or analog audio signals.
- You cannot record TV audio or radio digitally.
- You cannot record DTS signals included in DVDs and CDs.
- You cannot digitally record digitally-recorded CDRs.
- To record analog signals, set surround mode to STEREO. Otherwise, you cannot record even if you hear sound from the speakers.

■ CD dubbing (Digitally recording a CD with one button press)

1

Load a CD on the PDR-155's disc tray.

2

CD
DUBBING



MD-101A or CDR-201A

Press **CD DUBBING** on your Onkyo recorder (e.g., MD-101A or CDR-201A).

CD dubbing automatically starts.
(DLA link will not work.)

Notes

- The PDR-155's DIGITAL OUT jack should be connected to the DIGITAL INPUT 1 of the recording component.
- To perform the system recording function using an Onkyo component that is equipped with the **RI** jack, set the input source correctly.
- Connect the **RI** cable and audio pin cables correctly.

To record on an Onkyo recorder that does not have a CD DUBBING button, see page 98.

The PDR-155 does not support the synchronized recording function (**RI** recording system) described in your Onkyo recorder's instruction manual.

Recording

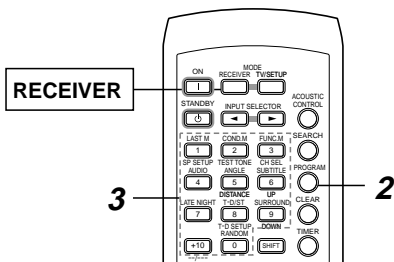

■ Program CD dubbing (Digitally recording only the favorite tracks)

1

Load a CD on the PDR-155's disc tray.

2



Press PROGRAM.

3

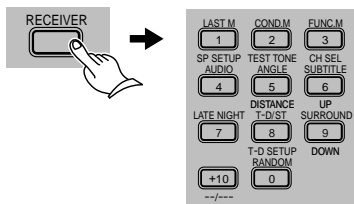

Press RECEIVER, then press the number buttons to specify the tracks you wish to record.

For example, to program tracks 9, 18, and 20 in this order, press number buttons 9, →+10, 8, →+10, +10, then 0.



4

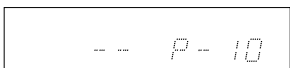

While the unit displays the Program window, press CD DUBBING on the MD-101A or CDR-201A.

CD dubbing automatically starts.
(DLA link will not work.)

MD-101A
or
CDR-201A



Notes

- The PDR-155's DIGITAL OUT jack should be connected to the DIGITAL INPUT 1 of the recording component.
- To perform the system recording function using an Onkyo component that is equipped with the **RI** jack, set the input source correctly.
- Connect the **RI** cable and audio pin cables correctly.

To record on an Onkyo recorder that does not have a CD DUBBING button, see page 98. The PDR-155 does not support the synchronized recording function (**RI** recording system) described in your Onkyo recorder's instruction manual.

Recording

■ Other recording

This section explains how to record on a Onkyo recorder that does not have a CD DUBBING button or another manufacturer's recorder. Refer to your recorder's instruction manual for information on recording.

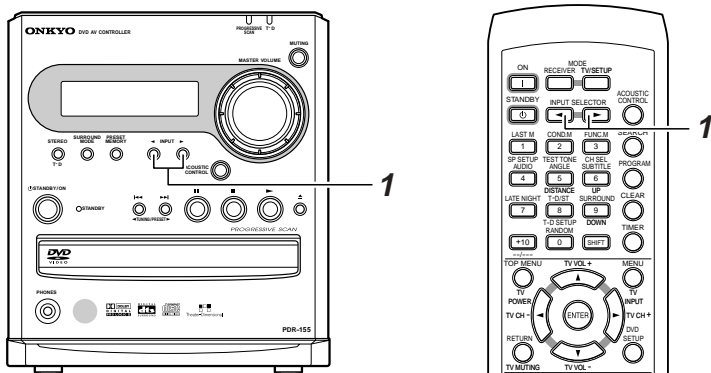

The remote controller buttons used in the following steps are illustrated inside a gray rectangle (■).

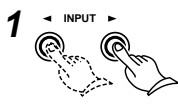

PDR-155

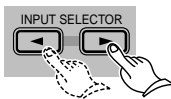

Remote controller

Press INPUT ► or ◀ on the PDR-155 or INPUT SELECTOR on the remote controller to select the recording source component.

2 Prepare the recording component.

- Place the recording component in record standby mode.
- Adjust the recording level on the recording component.
- Refer to your recorder's instruction manual for information on signal-synchronized recording (i.e., synchronized recording using input signal detection), or information on recording via its analog inputs.

3 Start recording.

Start playing the source component selected in Step 1.

Notes

- For digital recording, you need to connect the digital output of the source component to the digital input of the recording component.
- Do not change the input selection during recording. Otherwise, the recording cannot be made correctly.
- To record analog signals, set surround mode to STEREO. Otherwise, you cannot record.

Customizing the Function Settings

■ Using the Setup window



Using the Setup window enables you to set more parameters than the Setup Navigator (page 43). Use the Setup window when you wish to change the default settings. This section explains how to use the Setup window. If you have not set the parameters in Setup Navigator, the PDR-155 displays Setup Navigator first.

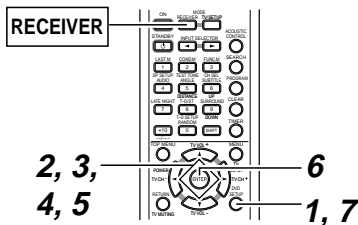

1

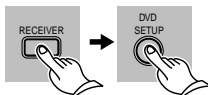

Press RECEIVER, then press DVD SETUP.

The unit displays the Setup window.

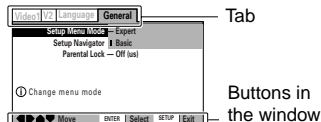

Tab

Buttons in the window

2



Press ◀/▶ to select one of the tabs (Video1, Video2, Language, and General).

3



Press ▲/▼ to select an item you wish to set.

4



Press ▶ to move the cursor to the value field.

5



Press ▲/▼ to select the desired option.

6



Press ENTER.

Repeat Steps 2-6 as necessary to set other items.

7



Press DVD SETUP.

Tips

- The DVD section is not initially activated when you turn on the power to the PDR-155. If the DVD section is not activated, press ▲ to activate it, then use Setup.
- If you turn off the PDR-155 during setup, the settings are canceled. To keep the settings, press DVD SETUP to complete the settings, then turn off the power to the unit.
- The memorized resume position (page 50) may be erased by the setup operation.
- If you display the Setup window after finishing the settings, the window reflects the settings you made most recently.

Customizing the Function Settings

Settings you can or cannot change depending on the type of discs

Depending on the disc type (DVD, video CD, audio CD, or MP3), you may be unable to set certain items. Refer to the color-coded indicators to the left of each item's value field and to the color code chart below.

indicator

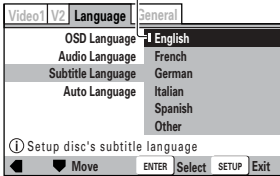

Color of indicator	Disc format(s)
Blue	DVD only
Green	All compatible formats
Yellow	DVD/Video CD

Settings items available only for DVDs

If you try to change a setting that is available only for DVDs while a non-DVD disc is in the tray, a blue DVD mark appears in the upper-right corner of the TV screen.

DVD mark

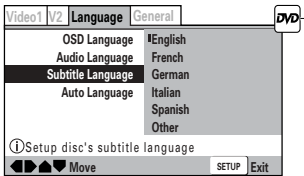

Settings you cannot change during playback

Settings you cannot change during playback are grayed out.

gray

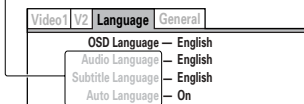

The **i** mark, indicating "information," is followed by a brief explanation of the selected item.

Customizing the Function Settings

■ Advanced settings

There are two categories of Setup window menus: [Basic] and [Expert]. Selecting [Expert] for [Setup Menu Mode] on the General page of the Setup window enables you to access advanced settings. In this manual, setting items you can access in [Expert] mode are identified by the  icon.

For more information on using the Setup window, see page 99.

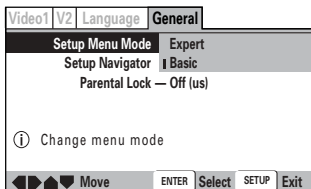

Expert:

You can access advanced settings in this mode.

Basic:

You can access basic settings in this mode. A brief explanation of the selected item (with the  mark) is also displayed. Basic mode is a factory default setting.

Customizing the Function Settings

■ Settings in the Video 1 page

Refer to page 99 for more information on using the Setup window.

Selecting the aspect ratio according to the TV ([TV Screen])

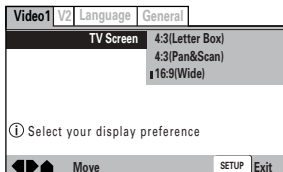

Set the aspect ratio to match the TV connected to the PDR-155. If the TV has a wide screen, select [16:9 (Wide)]. Many DVD movies support the wide screen format, and are recorded with an aspect ratio of 16:9. If you view such DVD movies on a regular TV screen (which has an aspect ratio of 4:3), the image will appear vertically stretched. To avoid this, if you are watching a regular TV screen, select [4:3 (Letter Box)] or [4:3 (Pan & Scan)]. You cannot change this setting during playback.

4 : 3 (Letter Box)



For letter box format movies on a regular TV screen

4 : 3 (Pan & Scan)



For pan & scan format movies on a regular TV screen

16 : 9 (Wide)



For wide-screen TVs

Tip

Some discs may not allow you to change the aspect ratio setting. For more information, check the disc jacket.

Setting the component video output

Compared to a standard interlaced TV picture, a progressive scan TV is capable of more stable, flicker-free images. Don't set this parameter if your NTSC color TV or monitor doesn't support progressive scan.

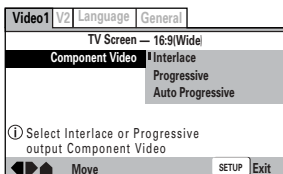

Interlace (Factory Setting)

Use this setting with regular TVs that do not feature progressive scan.

Progressive

Use this setting with TVs and monitors that feature progressive scan component video inputs.

Auto Progressive

The unit selects the progressive scan setting when 16:9 DVDs are played, and selects the interlace setting when 4:3 DVDs are played. Your TV/monitor must be compatible with progressive scan to use this setting.

Tip

If [Auto Progressive] is selected, the picture may flicker or be distorted when the unit switches between progressive and interlace modes. This is not a malfunction of either the PDR-155 or the TV.

If your TV does not switch between 4:3 and 16:9, change the aspect ratio of the TV to 4:3. Alternatively, set [Component Video] in the Setup window to [Interlace] or [Auto Progressive]. If you select [Auto Progressive], 4:3 discs will be played in Interlace mode, while discs that are recorded in both 4:3 and 16:9 will play in interlace mode during the 4:3 sections, and in progressive mode during the 16:9 parts. Switch your TV's aspect ratio to the most suitable setting (for more details, see the manual that came with your TV).

Notes

- If you connect a TV that is not compatible with a progressive scan signal and you choose progressive scan mode, you will not be able to see any picture at all. If your TV is connected via the composite or S video connectors, choose [Interlace] for [Component Video].
- This function only works with NTSC format DVDs.

Customizing the Function Settings

Switching the S video output Expert

You can switch the type of S-Video signals output from the S-Video connector. If you have connected your TV using an S-Video cable, in rare cases the TV picture may appear stretched. In such cases, switch the output from [S2] to [S1].

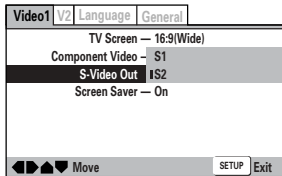

S2:

S2 video signals are output. (Factory setting)

S1:

S1 video signals are output.

Turning the Screen Saver On and Off Expert

To prevent the TV screen or monitor from being damaged by an image that remains displayed for a long time (a phenomenon called “screen burn”), the screen saver function is activated if the same screen has been displayed for about five minutes.

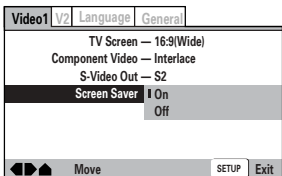

On:

The screen saver function is activated. (Factory setting)

Off:

The screen saver function is deactivated.

Items next to the Expert mark represent advanced settings. If these items are not displayed in the window, refer to page 101 for information on how to display them.

Customizing the Function Settings

■ Adjusting the picture quality

You can either select a pre-programmed setting designed to match certain program types or make adjustments to match your own preferences and save them in memory. You can adjust the picture quality while checking the playback image on TV. Refer to page 99 for more information on using the Setup window.

Selecting a pre-programmed setting

1

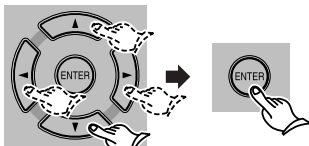

Use **▲/▼/◀/▶** to select [Video2] → [Video Adjust] → [Start], then press **ENTER**.

The quality adjustment window appears.

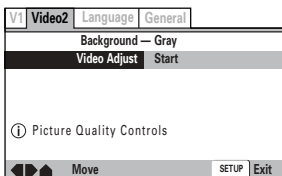

2-1

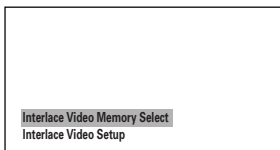

If you have selected [Interlace] for [Component Video] on the General page, select [Interlace Video Memory Select], then press **ENTER**.

2-2

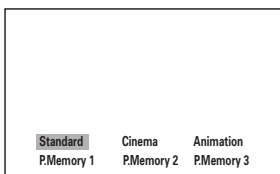

If you have selected [Progressive] for [Component Video] on the General page, select [Progressive Video Memory Select], then press **ENTER**.

3

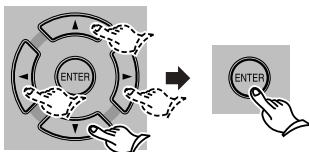

Press **▲/▼/◀/▶** to select the desired preset option, then press **ENTER**.

The quality adjustment window turns off. If the quality adjustment window disappears automatically before you press **ENTER**, the edited setting is cancelled.

Standard (Factory setting): Presents the video with no effect added.

Cinema: Delivers a cinema-like picture. Suitable for watching the screen in the dark like in a theater.

Animation: Provides images with bright clear colors.

P.Memory 1, P.Memory 2, and P.Memory 3: These are user-programmable settings. See "Adjusting the picture quality" on the next page for more information.

Customizing the Function Settings

■ Adjusting the picture quality

Depending on discs and the TV/monitor, you may not see the result of these adjustments clearly.

Creating your own quality setting

1

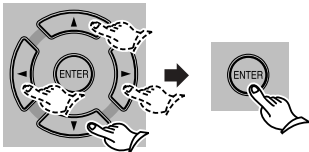

Press **▲/▼/◀/▶** to select **[Video2]** → **[Video Adjust]** → **[Start]**, then press **ENTER**.

The quality adjustment window appears.

2

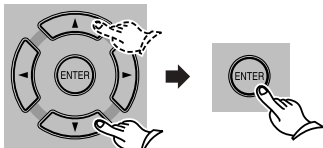

Press **▲/▼** to select **[Interlace Video Memory Select]**, then press **ENTER**.

- If you have selected **[Interlace]** for **[Component Video]**, **[Interlace Video Memory Select]** is available. If you have selected **[Progressive]** for **[Component Video]**, **[Progressive Video Memory Select]** is available.

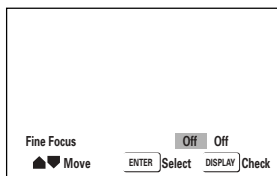

3

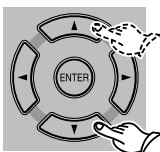

Press **▲/▼** to select the desired item to adjust, then press **DISPLAY** to display the parameter list of the selected item. Press **DISPLAY** again to display the previous window.

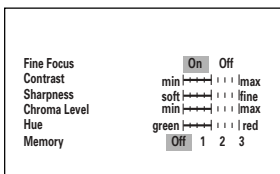

[Interlace] mode

Fine Focus

Switch **[On]** to reveal greater detail (higher resolution) in the picture.

Contrast

Adjusts the contrast of the elements in the picture.

Sharpness

Adjusts the sharpness of the mid-frequency (less detailed) elements in the picture. (This setting is only effective when **[Fine Focus]** is **[On]**.)

Chroma Level

Adjusts the color saturation level.

Hue

Adjusts the overall color balance between red and green. (This is effective only when the PDR-155 is connected via the VIDEO OUT or S VIDEO OUT jacks.)

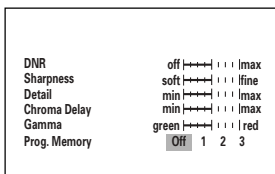

[Progressive] or [Auto Progressive] mode

DNR

Adjusts the amount of signal noise in the luminance component of the video signal.

Sharpness

Adjusts the sharpness of the mid-frequency (less detailed) elements in the picture.

Detail

Reveals greater detail (higher resolution) in the picture.

Chroma Delay

Adjusts luminance (Y) and color (C).

Gamma

Adjusts the brightness of the darker images in the picture.

Customizing the Function Settings

4

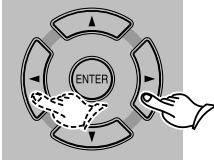

Press ◀/▶ to adjust the setting.

Select [On] or [Off] for [Fine Focus].

5

Repeat steps 3 and 4 to set other items.

To store the edited settings, press ▲/▼ to select [Memory], then press ◀/▶ to select [1], [2], or [3] and store the setting. Please note that if you select a memory location where settings have already been saved, the old settings will be replaced by the new ones.

6



Press ENTER.

The quality adjustment window disappears. If you do not press ENTER, the edited settings will not be stored in memory.

Customizing the Function Settings

■ Settings in the Video 2 page

Refer to page 99 for more information on using the Setup window.

Changing the background on the screen [Background]

You can select a background color on the screen when the PDR-155 is stopped.

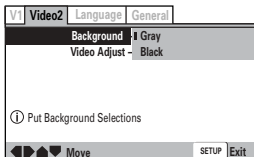

Gray:

The background is gray. (Factory setting)

Black:

The background is black.

Selecting the type of paused image to display [Still Picture] Expert

This function lets you view a clear still image when DVD playback is paused. With some discs, selecting [Field] for [Still Picture] may not improve the picture quality.

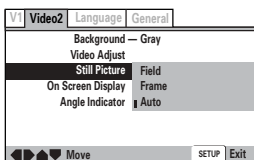

Field:

Picture flicker will be eliminated in pause mode.

Frame:

Standard mode

Auto:

Selects [Field] or [Frame] automatically according to the disc. (Factory setting)

Setting the position of the on-screen display [On Screen Display] Expert

You can specify the position of the Setup window and other on-screen displays on the TV screen according to the type of TV. Set this item if the DVD is recorded with a 4:3 aspect ratio. (Check the disc jacket for more information.) You can also eliminate the operation indicators (such as PLAY and STOP).

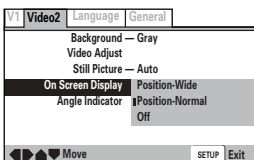

Position-Wide:

Select this to make sure that the entire window will be displayed when the picture is zoomed on a wide-screen TV.

Position-Normal:

Select this if "Normal" or "Full" has been selected on a wide-screen TV. (Factory setting)

Off:

No window is displayed.

Turning the angle mark on or off [Angle Indicator] Expert

You can set this item so that the angle mark  will not be displayed during playback.

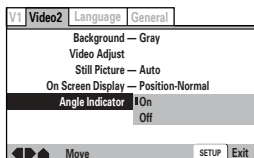

On:

 is displayed. (Factory setting)

Off:

 is not displayed.

Items next to the Expert mark represent advanced settings. If these items are not displayed in the window, refer to page 101 for information on how to display them.

Customizing the Function Settings

■ Setting the language options

Some DVD discs contain multiple subtitle languages and/or audio languages that you can select. This section outlines audio language and subtitle options. Refer to page 99 for more information on using the Setup window.

Setting the on-screen display language [OSD Language]

You can select a language to be used in the Setup window and on other on-screen display menus.

(Non-Asian models)

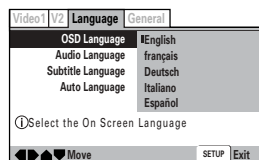

English
(Factory setting)
Français
Deutsch
Italiano
Español

(Asian models)

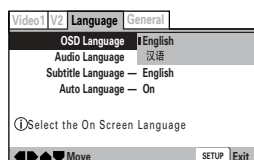

English
(Factory setting)
汉语

Note

The OSD (On Screen Display) screen shots in this manual were taken with the Language set to English (factory setting).

Selecting an audio language [Audio Language]

Select the desired audio language. You cannot set this item during playback.

(Non-Asian models)

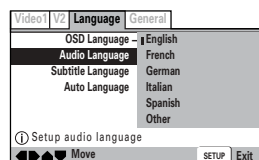

English
(Factory setting)
French
German
Italian
Spanish

(Asian models)

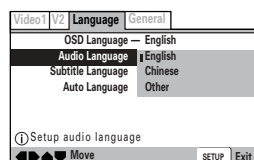

English
(Factory setting)
Chinese

Other: You can select from 136 languages. (For details on how to select other languages, see "If you have selected [Other]" on page 110.)

Other: You can select from 136 languages. (For details on how to select other languages, see "If you have selected [Other]" on page 110.)

Selecting a subtitle language [Subtitle Language]

Select the desired subtitle language. You cannot set this item during playback.

(Non-Asian models)

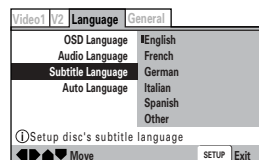

English
(Factory setting)
French
German
Italian
Spanish

(Asian models)

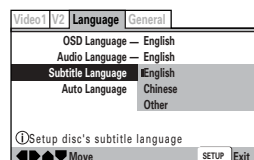

English
(Factory setting)
Chinese

Other: You can select from 136 languages. (For details on how to select other languages, see "If you have selected [Other]" on page 110.)

Other: You can select from 136 languages. (For details on how to select other languages, see "If you have selected [Other]" on page 110.)

Tip: If you select an audio or subtitle language that is not recorded on the disc, the default language on the disc will be automatically selected.

Customizing the Function Settings

Using the automatically-selected audio and subtitle language [Auto Language]

You can select whether the unit automatically uses the disc's default audio and subtitle language, or uses the languages specified in the Setup window. You cannot set this item during playback.

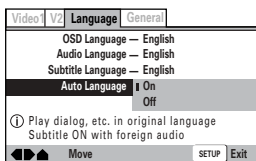

On:

The [Auto Language] setting is effective only when this item is set to [On], and [Audio Language] and [Subtitle Language] are the same (Factory setting). When [Auto Language] is [On], foreign movies are shown with the original audio soundtrack and subtitles in the language selected in [Subtitle Language]. Domestic films are shown with the original audio soundtrack and no subtitles. (This setting may not be effective with all DVDs.)

Off:

The unit uses the audio language selected by [Audio Language], and the subtitle language selected by [Subtitle language].

Selecting a DVD menu language preference [DVD Language] Expert

If a DVD contains a menu in different languages you can select one of the languages for the DVD. You cannot set this item during playback.

(Non-Asian models)

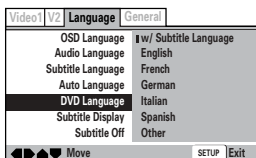

w/ Subtitle Language:

The menu window is displayed in the language specified by the [Subtitle Language] setting. (Factory setting)

English

French

German

Italian

Spanish

Other:

Select from 136 languages. (For details on how to select other languages, see "If you have selected [Other]" on page 110.)

(Asian models)

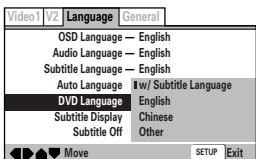

w/ Subtitle Language:

The menu window is displayed in the language specified by the [Subtitle Language] setting. (Factory setting)

English

Chinese

Other:

Select from 136 languages. (For details on how to select other languages, see "If you have selected [Other]" on page 110.)

Items next to the Expert mark represent advanced settings. If these items are not displayed in the window, refer to page 101 for information on how to display them.

Customizing the Function Settings

Turning the subtitle language on or off [Subtitle Display] **Expert**

You can select whether the subtitle language will or will not be displayed, or whether the assist subtitle language is displayed. You cannot set this item during playback.

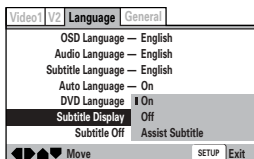

On:

The subtitle language is displayed. (Factory setting).

Off:

The subtitle language is not displayed. Some discs may automatically display the subtitle language that cannot be turned off. (See the below section.)

Assist Subtitle:

The assist subtitle explains the scenes for hearing impaired people. This subtitle appears only if it is recorded on the disc.

Forcing subtitles to be displayed [Subtitle Off] **Expert**

Even when the subtitles are turned off, some DVDs will nevertheless display them on the screen. This setting allows you to select the language of the subtitles to be displayed with this type of DVD. You cannot set this item during playback.

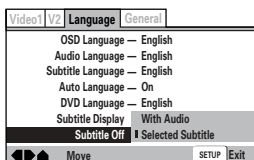

With Audio:

The subtitle is displayed in the language of the currently-playing audio.

Selected Subtitle:

The subtitle is displayed in the language specified by the [Subtitle Language] setting.

If you have selected [Other] for the subtitle, audio, or DVD language

Refer to the language code list on page 111 to select a language. If you have selected a language not recorded on the disc, the DVD menu uses one of the recorded languages.

1 Use **▲/▼/◀/▶** to select [Other] and press **ENTER**.

The language selection window appears.

2 Select [List of Language] or [Code].

With some languages, only the language code list may be displayed. For more information, refer to the language code list on page 111.

The numbers in parentheses next to the word “Code” indicate the range of numbers you can select.

If you select by “Code”

Follow one of the steps below:

Example: To select French

- Press number buttons 0, 6, 1, and 8.
- Press **▲/▼** to select a number for each digit. (Press **◀/▶** to move the cursor to other digits).

3 Press **ENTER**.

e.g., Audio language



If you select from the “List of Language”

Example: To select French

Press **▲** twice.

The items with the **Expert** mark are advanced settings. If they are not displayed in the window, refer to page 101 to display them.

Customizing the Function Settings

Language Code List

Language	Code
Japanese (ja)	1001
English (en)	0514
French (fr)	0618
German (de)	0405
Italian (it)	0920
Spanish (es)	0519
Chinese (zh)	2608
Dutch (nl)	1412
Portuguese (pt)	1620
Swedish (sv)	1922
Russian (ru)	1821
Korean (ko)	1115
Greek (el)	0512
Afar (aa)	0101
Abkhazian (ab)	0102
Afrikaans (af)	0106
Amharic (am)	0113
Arabic (ar)	0118
Assamese (as)	0119
Aymara (ay)	0125
Azerbaijani (az)	0126
Bashkir (ba)	0201
Byelorussian (be)	0205
Bulgarian (bg)	0207
Bihari (bh)	0208
Bislama (bi)	0209
Bengali (bn)	0214
Tibetan (bo)	0215
Breton (br)	0218
Catalan (ca)	0301
Corsican (co)	0315
Czech (cs)	0319
Welsh (cy)	0325
Danish (da)	0401
Bhutani (dz)	0426
Esperanto (eo)	0515
Estonian (et)	0520
Basque (eu)	0521
Persian (fa)	0601
Finnish (fi)	0609
Fiji (fj)	0610
Faroese (fo)	0615
Frisian (fy)	0625
Irish (ga)	0701
Scots-Gaelic (gd)	0704
Galician (gl)	0712
Guarani (gn)	0714

Language	Code
Gujarati (gu)	0721
Hausa (ha)	0801
Hindi (hi)	0809
Croatian (hr)	0818
Hungarian (hu)	0821
Armenian (hy)	0825
Interlingua (ia)	0901
Interlingue (ie)	0905
Inupiak (ik)	0911
Indonesian (in)	0914
Icelandic (is)	0919
Hebrew (iw)	0923
Yiddish (ji)	1009
Javanese (jw)	1023
Georgian (ka)	1101
Kazakh (kk)	1111
Greenlandic (kl)	1112
Cambodian (km)	1113
Kannada (kn)	1114
Kashmiri (ks)	1119
Kurdish (ku)	1121
Kirghiz (ky)	1125
Latin (la)	1201
Lingala (ln)	1214
Laothian (lo)	1215
Lithuanian (lt)	1220
Latvian (lv)	1222
Malagasy (mg)	1307
Maori (mi)	1309
Macedonian (mk)	1311
Malayalam (ml)	1312
Mongolian (mn)	1314
Moldavian (mo)	1315
Marathi (mr)	1318
Malay (ms)	1319
Maltese (mt)	1320
Burmese (my)	1325
Nauru (na)	1401
Nepali (ne)	1405
Norwegian (no)	1415
Occitan (oc)	1503
Oromo (om)	1513
Oriya (or)	1518
Panjabi (pa)	1601
Polish (pl)	1612
Pashto, Pushto (ps)	1619
Quechua (qu)	1721

Language	Code
Rhaeto-Romance (rm)	1813
Kirundi (rn)	1814
Romanian (ro)	1815
Kinyarwanda (rw)	1823
Sanskrit (sa)	1901
Sindhi (sd)	1904
Sangho (sg)	1907
Serbo-Croatian (sh)	1908
Sinhalese (si)	1909
Slovak (sk)	1911
Slovenian (sl)	1912
Samoan (sm)	1913
Shona (sn)	1914
Somali (so)	1915
Albanian (sq)	1917
Serbian (sr)	1918
Siswati (ss)	1919
Sesotho (st)	1920
Sundanese (su)	1921
Swahili (sw)	1923
Tamil (ta)	2001
Telugu (te)	2005
Tajik (tg)	2007
Thai (th)	2008
Tigrinya (ti)	2009
Turkmen (tk)	2011
Tagalog (tl)	2012
Setswana (tn)	2014
Tonga (to)	2015
Turkish (tr)	2018
Tsonga (ts)	2019
Tatar (tt)	2020
Twi (tw)	2023
Ukrainian (uk)	2111
Urdu (ur)	2118
Uzbek (uz)	2126
Vietnamese (vi)	2209
Volapük (vo)	2215
Wolof (wo)	2315
Xhosa (xh)	2408
Yoruba (yo)	2515
Zulu (zu)	2621

Customizing the Function Settings

■ Setting the parental lock level

The PDR-155 enables you to activate Parental Lock if a parental lock level is recorded on the disc. With such discs, you can block access to the material you feel is inappropriate for your children. Refer to the DVD jacket and the accompanying documentation to see if a particular disc contains a parental lock level. For example, if you set the PDR-155 to level 6, you will need to enter a password to play level 7 or level 8 discs. Refer to page 99 for more information on using the Setup window.

■ Entering a password

1

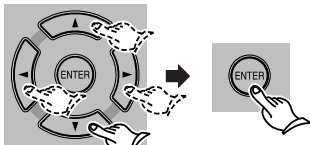

Use **▲/▼/◀/▶** to select **[General]** → **[Parental Lock]** → **[Password]**, then press **ENTER**.

The unit displays the Register Code Number window.

Before you select either **[Level]** or **[Country Code]**, you need to register the password (4-digit code number).

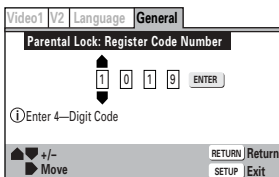
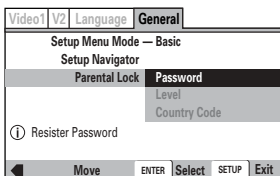

2

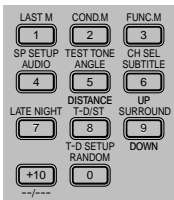

Enter a 4-digit password.

Follow one of the steps below.

- Press the number buttons.
- Press **▲/▼** to select a number for each digit. (Press **◀/▶** to move the cursor to other digits.)

3

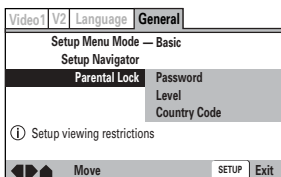

Press **ENTER**.

The unit displays the Setup window.

Password: Select this to change the password.

Level: Select this to change the parental lock level.

Country Code: Select this to change the country code.

Tips

- Write down your password so you will not forget.
- If you forget the password, restore the factory settings (page 118), then register the password again.
- With some discs, locked scenes will be skipped during playback.

Customizing the Function Settings

Changing the parental lock level

1

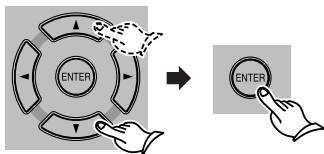

Select [Level], then press ENTER.

The unit displays the Register Code Number window.

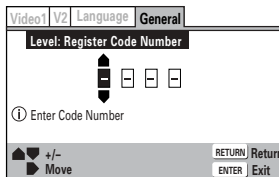

2

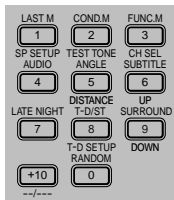

Enter the 4-digit password.

3



Press ENTER.

The unit displays the Level Change window. The factory setting is [Off].

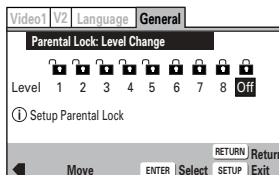

4

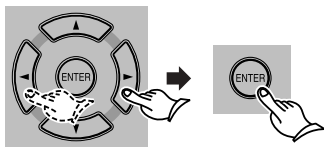

Press **◀/▶** to select the desired level, then press ENTER.

The parental lock level is set.

Playing a DVD disc that is locked

If you try to play a disc that has a parental lock, the unit may display the Register Code Number window. In this case, you need to enter the valid password to play the disc.

1 Press the number buttons to enter the 4-digit password.

2 Press ENTER.

Customizing the Function Settings

Changing the password

1

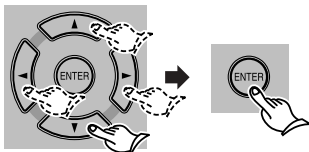

Select [Password] for [Parental Lock] on the General page of the Setup window, then press ENTER.

The unit displays the password entry window.

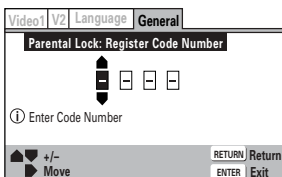

2

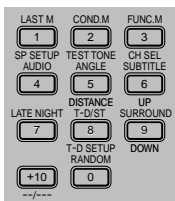

Enter your 4-digit password.

3



Press ENTER.

The unit displays the Register Code Number window.

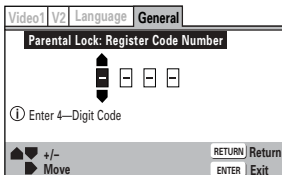

4

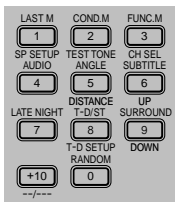

Enter a new 4-digit password.

5



Press ENTER.

The password has been changed.

Customizing the Function Settings

Setting the country code

Refer to the country code list on the next page during this procedure.

1

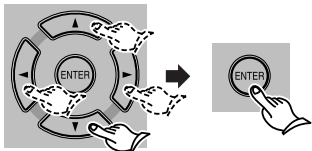

Select **[Country Code]** for **[Parental Lock]** on the **General** page, then press **ENTER**.

The unit displays the Register Code Number window.

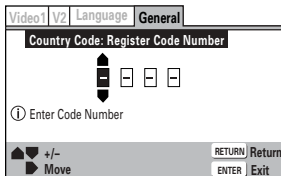

2

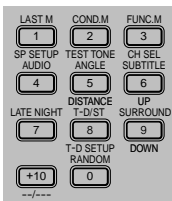

Enter your 4-digit password.

3



Press **ENTER**.

The unit displays the Country Code window.

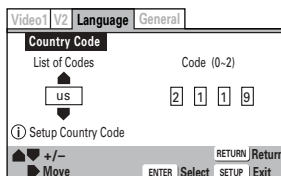

4

Select **[List of Codes]** or **[Code]**.

The numbers in the parentheses next to the word "Code" indicate the range of numbers you can select.

Selecting a Country Code from [Code]:

Follow one of the steps below:

Example: To select Japan

- Press number buttons 1, 0, 1, and 6.
- Press **▲/▼** to select a number. (Press **◀/▶** to move to the other digits.)

Selecting a Country Code from [List of Codes]

Example: To select Japan

Press **▲/▼** to select [j].

5



Press **ENTER**.

Customizing the Function Settings

Country Code List

Country	Code	List of codes
ARGENTINA	0118	ar
AUSTRALIA	0121	au
AUSTRIA	0120	at
BELGIUM	0205	be
BRAZIL	0218	br
CANADA	0301	ca
CHILE	0312	cl
CHINA	0314	cn
DENMARK	0411	dk
FINLAND	0609	fi
FRANCE	0618	fr
GERMANY	0405	de
HONG KONG	0811	hk
INDIA	0914	in
INDONESIA	0904	id
ITALY	0920	it
JAPAN	1016	jp
KOREA, REPUBLIC OF	1118	kr
MALAYSIA	1325	my
MEXICO	1324	mx
NETHERLANDS	1412	nl
NEW ZEALAND	1426	nz
NORWAY	1415	no
PAKISTAN	1611	pk
PHILIPPINES	1608	ph
PORTUGAL	1620	pt
RUSSIAN FEDERATION	1821	ru
SINGAPORE	1907	sg
SPAIN	0519	es
SWEDEN	1905	se
SWITZERLAND	0308	ch
TAIWAN, PROVINCE OF CHINA	2023	tw
THAILAND	2008	th
UNITED KINGDOM	0702	gb
UNITED STATES OF AMERICA	2119	us

Customizing the Function Settings

■ Memorizing the settings (Function memory)

The PDR-155 stores the settings of up to five items in Function memory.

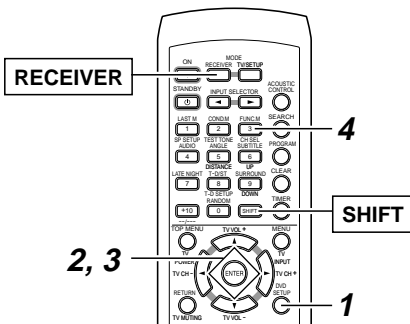

1

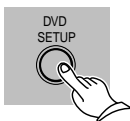

Press RECEIVER, then press DVD SETUP.

The unit displays the Setup window.

2

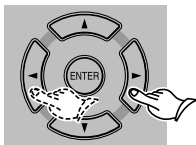

Press ◀/▶ to select a tab ([Video1], [Video2], [Language], or [General]).

3

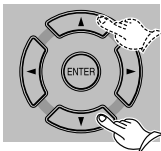

Press ▲/▼ to select the setting item to be memorized.

"FM" (Function memory) appears on the screen, and the setting is memorized.

4

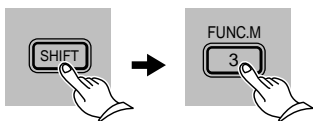

Press SHIFT, then press FUNC.M within 10 seconds.

To clear the settings from Function memory

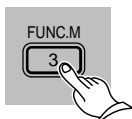

Press FUNC.M again.



The FM mark disappears, and the memorized settings are erased.

Note

Some settings cannot be memorized.

Customizing the Function Settings

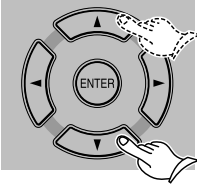
■ Recalling the settings from Function memory

1		<p>Make sure that the Setup window is <i>not</i> displayed, press SHIFT, then press FUNC.M within 10 seconds.</p> <p>Only the memorized items are displayed.</p>
2		<p>Press ▲/▼ to select the desired item.</p>
3		<p>Press ENTER.</p>

■ Restoring the PDR-155's factory default settings

You can restore the factory default settings for DVDs.

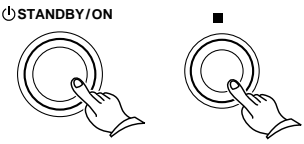
1	<p>Place the PDR-155 in Standby mode.</p>
2	 <p>While pressing and holding down ■ on the front panel, press STANDBY/ON to turn on the unit.</p> <p>All Setup items are reset to the factory default settings.</p> <p>Note This procedure will erase all settings in Program memory (page 60), Last memory (page 65), Condition memory (page 66), and the Setup items. Before you proceed, make sure you really want to do this.</p>

Operating the TV from Remote Controller

By programming the TV's remote control code, you can use the RC-506M remote controller to operate your TV.

■ Programming a TV remote control code

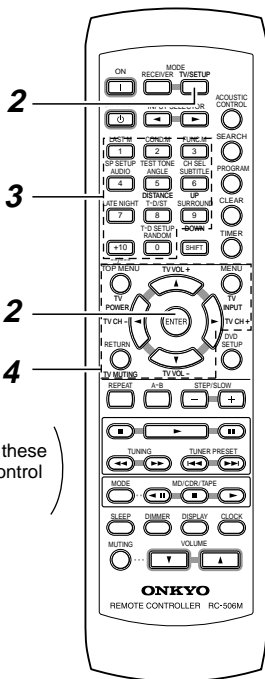

1 Find the three-digit number for the brand name of the component you want to operate in the table on the next page.

2 While pressing and holding down TV/SETUP, press ENTER, then release both buttons.

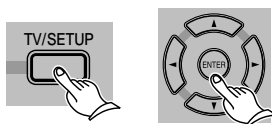

Release the buttons.

3 Enter the three-digit remote control code.

Press the number buttons to enter the code within 10 seconds. This time, you do not press RECEIVER. Use only the number buttons.

4 Make sure that the remote control code has been programmed correctly.

Press the remote controller buttons that control the TV to see if TV responds correctly.

Operating the TV from Remote Controller

■ TV remote control codes

- If more than one code is given in the table, try them one by one until you find the code suitable for your component (i.e. if the first code does not work, try the next one).

Brand	Remote control code
AIWA	100, 101
AKAI	102, 103, 104
AUDIOSONIC	105
BELL & HOWELL	106
BLAUPUNKT	107
BRIONVEGA	108, 109
CENTURION	110
COLTINA	111, 112, 113
CORONAD	114
CROWN	115, 116
DAEWOO	117, 118, 119, 120, 121
DUAL	122
EMERSON	123, 124, 125, 126, 127
FENNER	128, 129
FERGUSON	130, 131
FISHER	132
FUNAI	133, 134, 135
FUJITSU GENERAL	136, 137, 138
GE	139, 140, 141
GOLDSTAR	142, 143
GOODMANS	144
GRUNDIG	145, 146
HITACHI	147, 148, 149, 150
HYPER	151
INNO HIT	152
IRRADIO	103
JVC/VICTOR	153, 154, 155, 156, 157
KENDO	158
KTV	159, 160
LUXOR	161
MAGNAVOX	162, 163
MARANTZ	164
MARK	165
MATSUI	166, 167, 168, 169
mitsubishi	170, 171, 172, 173
MIVAR	174, 175
NEC	176, 177
NOKIA	178, 179, 180, 181
OCEANIC	181
NORDMENDE	182, 183
OKANO	152

Brand	Remote control code
ORION	184, 185, 186
PANASONIC	187, 188, 189, 190
PHILIPS	152, 162, 191
PIONEER	192, 193
PROSCAN	194
QUASAR	195
RADIO SHACK	196
RCA	110, 141, 197, 198, 199, 200
SABA	182, 183, 201
SAMSUNG	202, 203, 204, 205, 206, 207, 208
SANYO	209, 210, 211, 212
SCHNEIDER	103
SEARS	213
SELECO	214, 215
SHARP	216, 217
SONY	218, 219, 220, 221, 222, 223
SYMPHONIC	224, 225
TELEFUNKEN	201, 226, 227
THOMSON	228
TOSHIBA	213, 229
UNIVERSUM	230
ZENITH	231, 232

Troubleshooting

If you have any trouble, consult the following list.

The L-DR7 is designed to offer the best performance when you use a subwoofer SWA-155X, speakers D-M7 and D-M3, and a DVD AV controller PDR-155. Onkyo does not guarantee the performance and is not responsible for malfunctions caused by using other speakers or amplifiers.

Power	Pages
The power to the system is not turned on.	
• Make sure that the power cable is plugged into the AC outlet.	40
• Unplug the power cable from the AC outlet, wait for five seconds or more, then plug the cable in again.	
The power is turned off during the operation.	
• If the TIMER indicator is lit on the display, the timer is functioning. Cancel the timer.	94
• The PDR-155 enters Standby mode after the timer playback or recording is complete.	
Audio	
The sound is not heard.	
• Make sure that the subwoofer's power cable is plugged to the AC outlet.	40
• Make sure that the multi-split cable is connected correctly. Make sure that you do not mix the SUBWOOFER CONTROL jack on PDR-155's rear panel with the RI jack.	29
• Make sure that the speakers are connected correctly and the speaker cables' core wires touch the speaker connectors.	30
• Make sure that the correct input source is selected. You need to select the connected component as the input source.	42
• Check to see if the volume level is set to minimum.	46
• Check to see if the muting function is working. If the MUTING indicator is flashing, the sound is muted. Cancel the muting function.	47
• Check the output setting on the connected playback component.	
• Make sure that the component is connected via the correct input jacks.	32–37
• Make sure that the input setting on the connected component is correct.	
• Audio is not output during pause, slow playback, fast forward, and fast backward. Press ► to resume playback.	
Audio is output in monaural.	
• While playing a video CD or MP3 file disc, if you press AUDIO and select 1/L (left) or 2/R (right), audio is output in monaural. To switch back to stereo, press AUDIO and select stereo. Note: The setting is displayed on the screen. Connect the TV to check the setting on the screen.	64
About tonal quality	
Tonal quality will improve and become stable about 10–30 minutes after you plug in the unit. Tonal quality may be damaged if you bundle the multi-splitter cable along with the speaker cords.	
Home theater	
Sound is not good.	
• Make sure that the speaker cords are connected correctly. Check their polarity (+/-).	30
• Set each speaker's distance and volume level.	76
• Connect the audio pin cables firmly.	
No sound is output from the center speaker, surround speakers, or subwoofer.	
• In some surround modes, sound is not output from these speakers. STEREO: Sound is output only from the front speakers and subwoofer. No sound is output from the center speaker and surround speakers. ORCHESTRA: No sound is output from the center speaker.	

Troubleshooting

- Sound may not be heard clearly when certain sources play in DOLBY PRO LOGIC II surround mode. Signals or sound effects to create realistic scenes are sometimes included on the DVDs and BS digital broadcasts that support 5.1ch. However, they are not included in CDs and standard broadcasts. Select another surround mode.
 - Make sure that the speakers are connected correctly and the speaker cables' core wires touch the speaker connectors. 30
-

Sound from the connected turntable is very soft.

- Check to see if the turntable has an internal phono equalizer. If it does not have a phono equalizer, obtain an optional one.
-

Playing a record on the turntable does not produce sound.

- If you are using a turntable with an MC cartridge, you will need a transformer or head amplifier to boost the voltage, and a phono equalizer.
-

Disc playback

The disc will not play.

- Make sure that the disc has been loaded on the disc tray correctly. The disc should be inserted with the playback side facing down. 49
 - Check to see if the disc surface is dirty.
 - Make sure that the disc type is supported by the unit. 11
 - If the unit displays "Wrong Region No," the unit does not support the region number and cannot play the disc. 11
 - Parental lock is applied. Release the lock or change the lock level. 112
 - If condensation is suspected, wait for about one hour after you turn on the power to the unit.
-

The disc will not play tracks in order.

- Cancel special playback modes, such as Repeat playback, Memory playback, and Random playback. 56–62
-

Setup

The setting window does not appear.

- Turning on the power to the PDR-155 does not activate the DVD section. Insert a DVD disc, press PLAY, then press STOP. Then proceed to the settings. 48
-

The settings are erased.

- The power outage or removal of the power cable may erase the settings.
-

The settings cannot be changed.

- If the DVD mark appears on the screen, you have tried to set an item that is only available for DVDs, while an audio CD, video CD, or MP3 file disc is in the tray. 100
 - Some settings cannot be changed during playback. First, stop playback, then try again.
-

The Setup window does not display the desired setting item.

- [Setup Menu Mode] has been set to [Basic]. Change it to [Expert]. 101
-

Picture

Playback images are sometimes distorted.

- Depending on the compatibility with a TV that supports progressive picture, the progressive image may be affected. In this case, select Interlace mode. You can still watch progressive images on TV.
 - Check to see if the disc surface is dirty.
 - The first forward or backward operation may cause distortion. This is not a malfunction.
-

Troubleshooting

The brightness of the playback image is not stable, or some visual noise is displayed.

- If the PDR-155 is connected to TV through a VCR, the copy-protect function is activated. Connect the unit directly to the TV. 27
- Depending on the TV or monitor, the color level may be lighter or the tint may be different. In this case, adjust the picture quality using the PDR-155's controls. 104

The image does not appear on the screen.

- Make sure that the input setting on the connected TV or amplifier is correct.
- If a still image is displayed for a long time while the unit is stopped or paused, the screen saver function is activated. Press PLAY to cancel Pause or Stop mode. 50
- If the background color has been set to black, the image may not be seen on the screen while the unit is stopped. In this case, select gray for the background. 107
- If the unit is connected to the TV's component connectors, first initialize the settings, then select [Interlace] for [Component Video] in the Setup window. 102

The image is stretched horizontally or vertically.

- The [TV Screen] setting does not match the TV screen type. Use Setup Navigator or Setup window to set the parameter correctly. 102
- If the unit is connected to the TV via the S video connector, the TV circuit may stretch the image vertically. In this case, set [S Video Output] to S1. 103

MP3 playback

You cannot play back MP3 files on the disc.

- Check to confirm that the disc conforms to ISO9660. 12
- Make sure that the disc has been finalized.

You cannot select a track (MP3 file) recorded on the disc.

- Files with any extension other than ".mp3" or ".MP3" are not recognized. Change the file extension. 12
- The PDR-155 cannot recognize more than 250 folders or tracks. 12
- The PDR-155 does not support multi-session discs. It will play only the first session of a multi-session disc. 12

Miscellaneous

The desired subtitle language is not displayed or the desired audio language is not output.

- The selected language is not recorded on the disc.
- When [Auto Language] is set to [On], domestic films are shown with the original audio soundtrack and no subtitles. (This is not effective with all DVDs.) 109

The mark (Prohibited by the disc) appears on the screen.

- The disc prohibits the operation. 12

The mark (Prohibited by the player) appears on the screen.

- The PDR-155 prohibits the operation. 12

Radio

Noise is heard during broadcast, or too much white noise is heard during an FM stereo broadcast.

You cannot tune in the broadcast station using the Auto Preset function (for only FM stations).

Or, the FM STEREO indicator does not light up during FM broadcast.

- Change the location of the antenna.
- Locate the unit further from the TV or a computer. 10
- Cars or airplanes can create noisy interference.
- A broadcast radio signal may be weak if a concrete wall obstructs the signal path.
- Try setting FM mode to "Monaural." 82
- Noise may be heard when you operate the remote controller during AM reception.
- If nothing can improve the reception, install an outdoor antenna. 39

Troubleshooting

Remote controller	Pages
The remote controller does not function correctly. Or, the TV does not respond to the remote controller operation.	
• Make sure that the batteries have been installed in the correct direction (polarity +/-).	18
• Replace both batteries with new ones. (Do not mix different types of batteries or new and old batteries.)	18
• The distance between the remote controller and the unit may be too far. Or, there may be an object between them.	18
• The remote control sensor on the unit may be receiving a strong beam of light (inverter fluorescent light or sunlight).	18
• The unit is placed behind the tinted windows of the audio rack or entertainment center.	18
• Make sure that the TV code has been programmed in the remote controller correctly. Find the TV's remote control code in the remote control list and reprogram it.	119
• If you have connected an external component, set the input indication correctly.	42

Onkyo components system connection	
No sound is output from the connected component.	
• Check the input source setting.	46
• Make sure that the input source indication is switched correctly.	42
• Check to see if the optical digital cable is bent or damaged.	
• Add an optional phono equalizer if the turntable does not include a phono equalizer.	

You cannot record.

- To perform digital recording, connect the digital output of the playing component to the digital input of the recording component.
- Try recording by using the CD DUBBING button. If your Onkyo recorder does not have a CD DUBBING button, or you are using another manufacturer's recorder, use the other recording method, or use synchronized recording using input signal detection. The PDR-155 does not support the synchronized recording function (RI recording system) described in your Onkyo recorder's instruction manual. Refer to your recorder's instruction manual for information on recording.
- Make sure that the system is connected correctly. 32-37

The system functions do not work.

- Make sure that the RI cable and audio pin cables are connected correctly.
(Connecting only the RI cable does not complete the system connection.) 32-37
- Switch the input source indication correctly. 42

Timer playback or recording does not work.

- The clock should be set correctly.
If the clock is not set, timer playback or recording does not work. Make sure you program the current time. 78
- Make sure that the RI cable and audio pin cables are connected correctly. 32-37
- Check the settings of the playback and recording components. (You cannot perform timer recording with a CD recorder.)

The colors of the TV picture bleed.

- Locate the speakers far from the TV.

This product uses a micro computer to perform various advanced functions. However, noise, radio interference, or static electricity could occasionally cause the unit to malfunction. In this case, unplug the power cable from the AC outlet, then plug it in again in five seconds.

Onkyo is not responsible for damages (such as CD rental fees) due to unsuccessful recordings caused by the unit's malfunction. Before you record important data, make sure that the material will be recorded correctly.

Restoring the factory default settings:

To reset all the stored settings to the factory default conditions, while the power to the PDR-155 is on, press and hold down the PRESET MEMORY on the unit, and press STANDBY/ON. The unit displays "CLEAR," and restores the factory default settings, then enters Standby mode.

Specifications

■ PDR-155 (DVD AV controller)

Input/Impedance

Digital TV: OPTICAL -21~ -15 dB
Analog TV/LINE, MD/TAPE, CDR/VIDEO: RCA L/R (200 mV/50 kΩ)

Nominal output/Impedance

REC OUT (MD/TAPE, CDR/VIDEO): 200 mV/2.2 kΩ
MULTI CH OUTPUT (Front L/R, Surround L/R, Center, Subwoofer): 1 V/470 Ω
Frequency response Front, Surround: 120 Hz to 20 kHz, +1/-3 dB (STEREO mode)
Subwoofer: 20 Hz to 120 Hz, + 1/-6 dB (STEREO mode)

Signal-to-noise ratio (S/N): more than 100 dB

Harmonic distortion: less than 0.08%

Acoustic controls

- 1: +10 dB (82 Hz) subwoofer
- 2: +10 dB (82 Hz) subwoofer
+6 dB (10,000 Hz) front

Muting : -60 dB

TUNER SECTION

• FM

Tuning range : 87.50 to 108.00 MHz (50 kHz steps)
Usable sensitivity Mono: 11.2 dBf, 1.0 μV (75 Ω)
Stereo: 17.2 dBf, 2.0 μV (75 Ω)

Capture ratio: 2.0 dB
Image rejection ratio South America: 40 dB
Others: 85 dB

IF rejection ratio: 90 dB
Signal-to-noise ratio Mono: 73 dB
Stereo: 67 dB

Alternate channel att.: 55 dB
AM suppression ratio: 50 dB
Harmonic distortion (1 kHz) Mono: 0.2%
Stereo: 0.3%

Frequency response: 30 to 15,000 Hz, ±1.0 dB
Stereo separation: 45 dB (1 kHz) 30 dB (100 to 10,000 Hz)
Muting level: 17.2 dBf
Antenna impedance: 75 Ω

• AM

Tuning range: South America: 530 to 1710 kHz (10 kHz steps)
Others: 522 to 1611 kHz (9 kHz steps)

Usable sensitivity: 30 μV
Image rejection ratio: 40 dB
IF rejection ratio: 40 dB
Signal-to-noise ratio: 40 dB
Harmonic distortion (400 Hz): 0.7%
Clock precision: monthly error, ±30 seconds (25°C)

Specifications

DVD SECTION

Signal readout system: PAL/AUTO color television system

Laser: Semiconductor laser, wavelength 650 nm (DVD)/780 nm (CD)

Digital audio frequency response

DVD linear audio: 48 kHz sampling 4 Hz - 22 kHz
96 kHz sampling 4 Hz - 44 kHz

CD audio: 4 Hz - 20 kHz

Signal-to-noise ratio (digital audio): 100 dB

Audio dynamic range (digital audio): 96 dB

Harmonic distortion (digital audio): 0.01%

Wow and flutter: Measuring limit [$\pm 0.001\%$ (W, PEAK)] or less

Operating conditions

Temperature: 5°C to 35°C

Operation status: Horizontal

Connectors

Video output: 1.0 V (p-p), 75 Ω , negative synch, pin jack x 1

S VIDEO: (Y) 1.0 V (p-p), 75 Ω , negative synch, mini DIN4 pin jack x1
(C) 0.286 V (p-p), 75 Ω

COMPONENT: (Y) 1.0 V (p-p), 75 Ω
(PR), (PB) 0.7 V (p-p), 75 Ω , COMPONENT jacks x 3

AUDIO OUTPUT (optical): -22.5 dBm x 2

AUDIO OUTPUT (analog): 2.0 V (rms), 470 Ω , pin jacks (L, R) x 2

GENERAL

Power supply AC 120 V, 60 Hz
AC 220–230 V, 50/60 Hz
AC 230–240 V, 50 Hz

Power consumption: 33 W

Power consumption (standby mode): 2.5 W

Dimensions (W x H x D): 155 mm x 172.5 mm x 289.5 mm

Weight: 3.5 kg (7.7 lbs.)

Specifications

■ SWA-155X (subwoofer)

INPUT: RCA L/R/C/SL/SR/ subwoofer (500 mV/47 k Ω)

AMPLIFIER SECTION

Power output	Front:	15 W x 2 (6 Ω /EIAJ)
	Center:	15 W (6 Ω /EIAJ)
	Surround:	15 W x 2 (6 Ω /EIAJ)
	Subwoofer:	25 W (3 Ω /EIAJ)
	Front:	11 W x 2 (6 Ω /DIN)
	Center:	11 W (6 Ω /DIN)
	Surround:	11 W x 2 (6 Ω /DIN)
	Subwoofer:	20 W (3 Ω /DIN)

Total harmonic distortion: 0.1% (Output: 5 W)

Signal-to-noise ratio: 100 dB (STEREO: IHF A 0.5 V input)

SPEAKER SECTION

Type: J'DRIVE system, 16 cm OMF cone

GENERAL

Power supply AC 120 V, 60 Hz
AC 220–230 V, 50/60 Hz
AC 230–240 V, 50 Hz

Power consumption: 65 W

Power consumption (Max.): 135 W

Dimensions (W x H x D): 185 mm x 299 mm x 312 mm

Weight: 8 kg

Others: Magnetic shielding (EIAJ)

■ D-M7 (speaker)

Type: 8 cm OMF cone (One for each)

Dimensions (W x H x D): 102 mm x 210 mm x 142 mm

Weight: Each 1.1 kg

Others: Magnetic shielding (EIAJ)

■ D-M3 (speaker)

Type: 8 cm OMF cone (One for each)

Dimensions (W x H x D): 85 mm x 120 mm x 112 mm

Weight: Each 0.6 kg

Others: Magnetic shielding (EIAJ)

■ RC-506M (remote controller)

Transmitter: Infrared

Signal range: Approx. 16 ft., 5 meters

Power supply: Two "AA/R6" batteries (1.5 V x 2)

Specifications and features are subject to change without notice.

ONKYO CORPORATION

Sales & Product Planning Div. : 2-1, Nisshin-cho, Neyagawa-shi, OSAKA 572-8540, JAPAN
Tel: 072-831-8111 Fax: 072-831-8124 <http://www.onkyo-intl.com>

ONKYO U.S.A. CORPORATION

18 Park Way, Upper Saddle River, N.J. 07458, U.S.A.
Tel: 201-785-2600 Fax: 201-785-2650 <http://www.onkyousa.com>

ONKYO EUROPE ELECTRONICS GmbH

Liegnitzerstrasse 6, 82194 Groebenzell, GERMANY
Tel: +49-8142-4401-0 Fax: +49-8142-4401-555 <http://www.onkyo.net>

ONKYO CHINA LIMITED

Units 2102-2107, Metroplaza Tower I, 223 Hing Fong Road, Kwai Chung,
N.T., HONG KONG Tel: 852-2429-3118 Fax: 852-2428-9039



<http://www.onkyo.co.jp/>